

Valvole di sequenza

Sequence valves

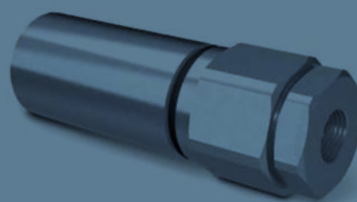

Le valvole di sequenza sono elementi che devono aprirsi al raggiungimento di una pressione prestabilita, consentendo il passaggio del fluido in un'altra parte dell'impianto idraulico. La loro apertura dipende quindi dalla pressione esistente nel loro condotto di ingresso. La pressione nel circuito che ha provocato l'apertura viene mantenuta inalterata ed uguale a quella di taratura, durante l'apertura della valvola. Quando la pressione nel condotto di ingresso scende sotto il valore di taratura, la valvola si chiude.

Sequence valves are elements that open when an established pressure value is reached, allowing the fluid to pass to another part of the circuit. Therefore the opening depends upon the existing upstream pressure. The pressure in the circuit that provokes the opening is kept equal to the setting value, when the valve is open.

When pressure upstream decreases under the setting pressure value, the valve closes.

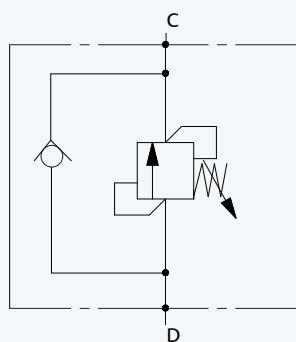

Dirette non compensate
Direct not compensated

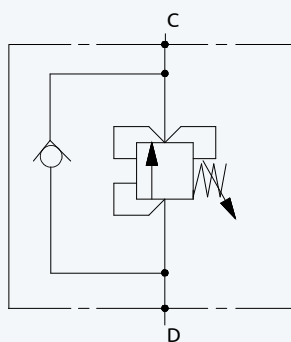

Diretta compensata
Direct compensated

Tali valvole vengono utilizzate, ad esempio, quando è necessario far muovere gli attuatori di un circuito idraulico secondo un ordine prestabilito, al raggiungimento di un determinato valore di pressione. Una valvola unidirezionale permette di cortocircuitare il sistema quando si ha il flusso nel verso opposto.

Sono disponibili nelle versioni:

- dirette non compensate;
- dirette compensate: insensibili alla contropressione che può esserci nel ramo secondario.

Caratteristiche:

Vengono realizzate sia con corpo e colonnetta, sia in corpi esagonali, con ridotti ingombri e adatti ad essere montati in linea con i tubi.

Presentano:

- Ampio campo di taratura;
- Ridotti tempi di apertura e chiusura;
- Ridotte perdite in attraversamento.

Le curve a catalogo mostrano le perdite di carico nelle due direzioni D>C e C>D con molla senza precarico.

Con valori di taratura uguali o inferiori al valore minimo di catalogo le valvole possono presentare instabilità e rumorosità.

Such valves are used, for example, when it is necessary to move the actuators of a circuit with an established order, when a determined pressure value is reached. A check valve allows to shortcut the system when there is flow in the opposite direction.

These valves are available in two versions:

- direct not compensated;
- direct compensated, not affected by the possible back pressure on the other side.

Features:

They are realized both with body and stud bolt, and hexagonal body, obtaining reduced cumbersome and suitability to be installed in line with the pipes.

These valves offer:

- Wide setting range;
- Reduced response time;
- Reduced pressure drops.

In the catalogue are shown the pressure drops curves for both the directions D>C and C>D, and they are related to the valve spring with no preload.

If the valve is set at the lowest setting value or below the value indicated in the catalogue, instability and noise can occur.



Valvola di sequenza compensata Pressure compensated sequence valve

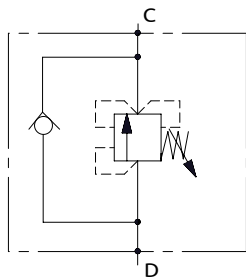

PRESSIONE / PRESSURE - Δp (bar)

CURVE CARATTERISTICHE
PERFORMANCE CURVES

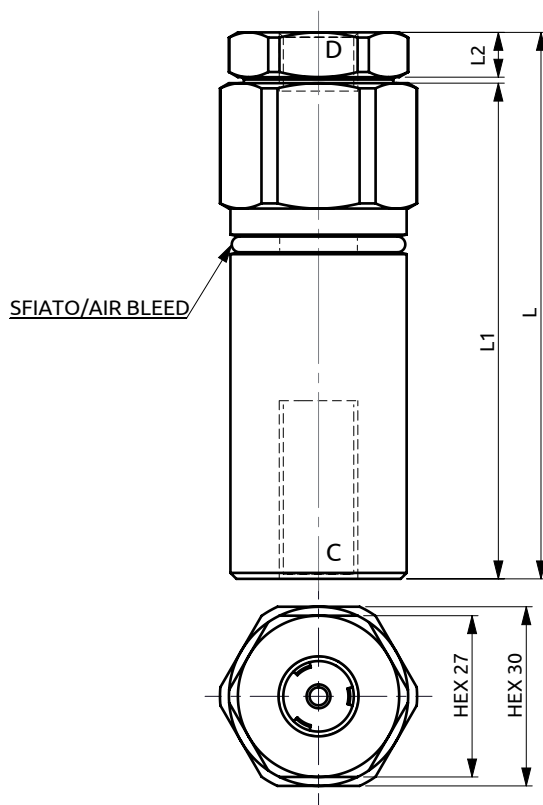
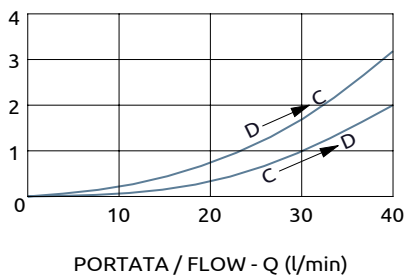

91.5	83	8
L	L1	L2



DESCRIZIONE

Valvola di sequenza con taratura regolabile. Disponibile con due differenti attacchi d'estremità.

DESCRIPTION

Sequence valve with adjustable setting. Available with two different outlet ports.

Codice Ordinazione	Campo di Taratura	Taratura Standard	Incremento per giro	Portata Massima	Pressione Max	Dimensione Porte	Peso
Ordering Code	Pressure Range	Standard Setting	Pressure Increase	Max Flow	Max Pressure	Port Size	Weight
A040201.01.00	40-160 bar	60 bar	38 bar/turn	20 l/min	500 bar	1/4"G	0.35 kg
A040301.01.00	40-160 bar	75 bar	38 bar/turn	40 l/min	500 bar	3/8"G	0.33 kg
A040301.02.00	100-280 bar	150 bar	66 bar/turn	40 l/min	500 bar	3/8"G	0.33 kg



Valvola di sequenza compensata

Pressure compensated sequence valve

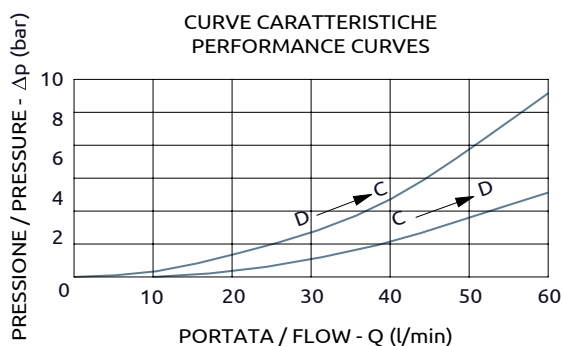
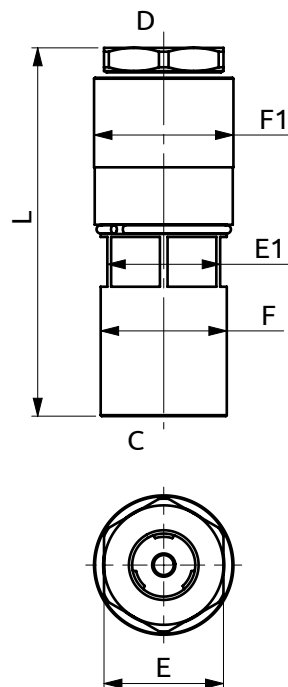
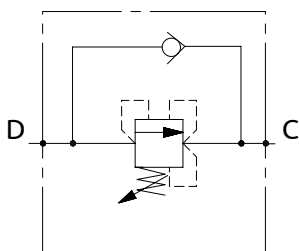

Corpo in acciaio / Steel body

A040401.17.00	111	Ø38	Ø42	HEX36	HEX34
COD.	L	F	F1	E	E1



DESCRIZIONE	DESCRIPTION
Valvola di sequenza con taratura regolabile.	Sequence valve with adjustable setting.

Codice Ordinazione	Campo di Taratura	Taratura Standard	Incremento per Giro	Portata Massima	Pressione Max	Dimensione Porte		Peso
Ordering Code	Pressure Range	Standard Setting	Pressure Increase	Max Flow	Max Pressure	Port Size		Weight
A040401.17.00	50-150 bar	90 bar	~30 bar/turn	60 l/min	500 bar	D, C	1/2"G	0.8 kg



Valvola di sequenza compensata

Pressure compensated sequence valve

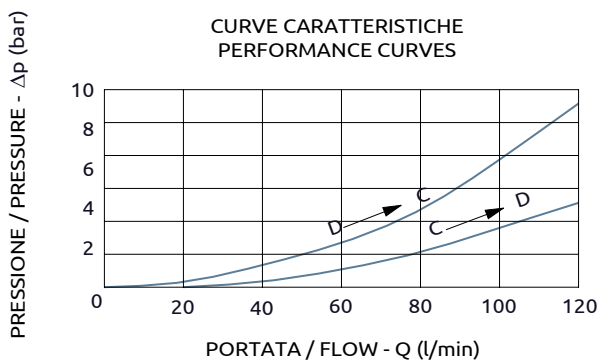
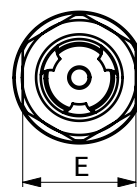
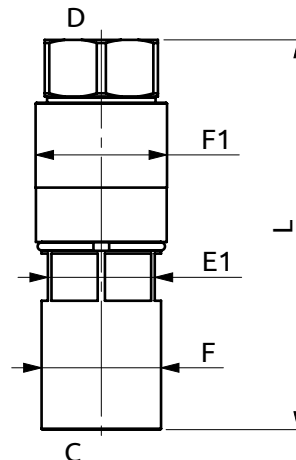
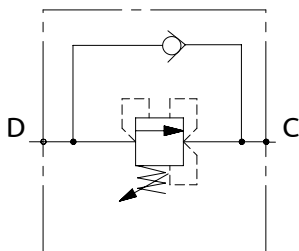

Corpo in acciaio/Steel body

A040601.14.00	124	Ø38	Ø42	HEX36	HEX34
A040601.15.00	124	Ø38	Ø42	HEX36	HEX34
A040601.18.00	124	Ø38	Ø42	HEX36	HEX34
COD.	L	F	F1	E	E1



DESCRIZIONE	DESCRIPTION
Valvola di sequenza con taratura regolabile.	Sequence valve with adjustable setting.

Codice Ordinazione	Campo di Taratura	Taratura Standard	Incremento per Giro	Portata Massima	Pressione Max	Dimensione Porte		Peso
Ordering Code	Pressure Range	Standard Setting	Pressure Increase	Max Flow	Max Pressure	Port Size		Weight
A040601.14.00	50-120 bar	90 bar	~30 bar/turn	120 l/min	500 bar	D, C	3/4"G	0.8 kg
A040601.15.00	150-280 bar	150 bar	~46 bar/turn	120 l/min	500 bar	D, C	3/4"G	0.8 kg
A040601.18.00	100-160 bar	150 bar	~30 bar/turn	120 l/min	500 bar	D, C	3/4"G	0.8 kg



Valvola di sequenza compensata

Pressure compensated sequence valve

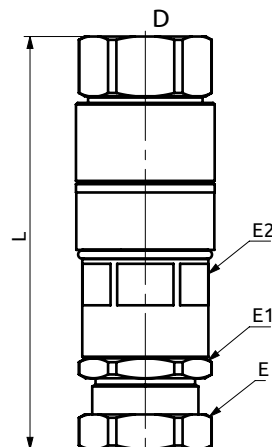
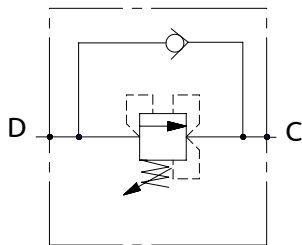

Non svitare oltre Lmax
Do not unscrew more than Lmax

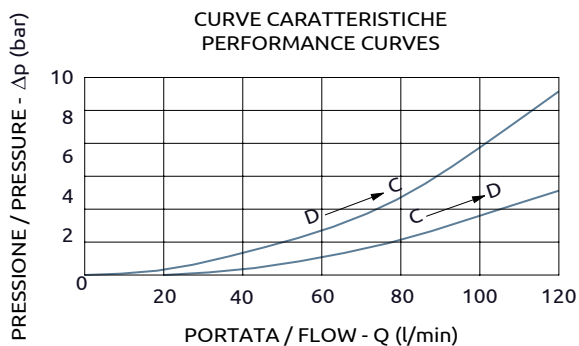
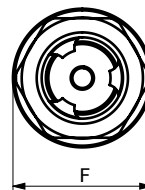

Corpo in alluminio/Aluminium body

A040403.01.00	~112.5	~113	Ø41.8	HEX36	HEX36	HEX34
A040603.01.00	~124.5	~126	Ø41.8	HEX36	HEX36	HEX34
COD.	L	Lmax	F	E	E1	E2



DESCRIZIONE	DESCRIPTION
Valvola di sequenza con taratura regolabile.	Sequence valve with adjustable setting.

Codice Ordinazione	Campo di Taratura	Taratura Standard	Incremento per Giro	Portata Massima	Pressione Max	Dimensione Porte		Peso
Ordering Code	Pressure Range	Standard Setting	Pressure Increase	Max Flow	Max Pressure	Port Size		Weight
A040403.01.00	50-150 bar	65 bar	~50 bar/turn	60 l/min	400 bar	D, C	1/2"G	0.82 kg
A040603.01.00	50-150 bar	100 bar	~50 bar/turn	120 l/min	400 bar	D, C	3/4"G	0.82 kg



Valvola di sequenza in linea Sequence valve

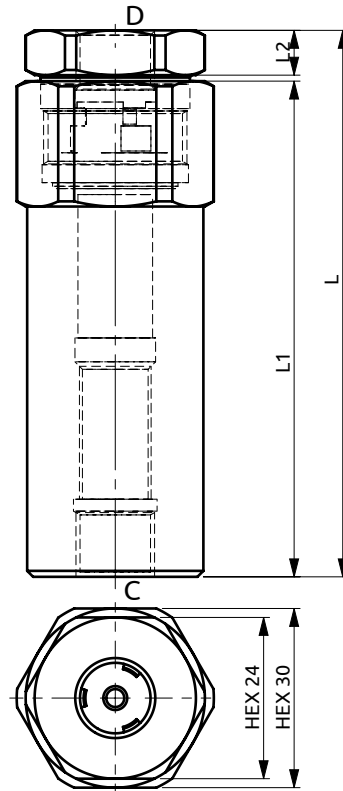
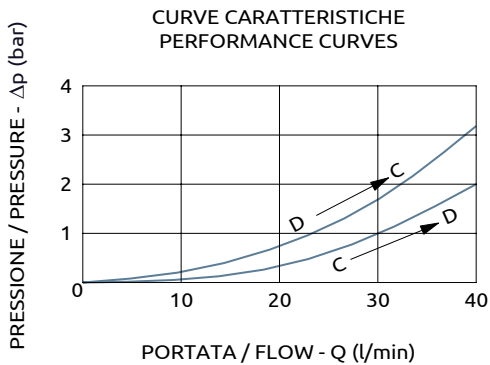
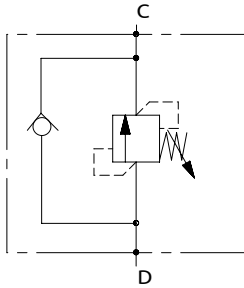

91.5	83	7.5
L	L1	L2



DESCRIZIONE	DESCRIPTION
Valvola di sequenza con taratura regolabile. Disponibile con due differenti attacchi d'estremità.	Sequence valve with adjustable setting. Available with two different outlet ports.

Codice Ordinazione	Campo di Taratura	Taratura Standard	Incremento per giro	Portata Massima	Pressione Max	Dimensione Porte	Peso
Ordering Code	Pressure Range	Standard Setting	Pressure Increase	Max Flow	Max Pressure	Port Size	Weight
A040251.01.00	50-140 bar	60 bar	26 bar/turn	20 l/min	500 bar	1/4"G	0.35 kg
A040251.02.00	15-80 bar	30 bar	14 bar/turn	20 l/min	500 bar	1/4"G	0.35 kg
A040351.01.00	50-140 bar	140 bar	26 bar/turn	40 l/min	500 bar	3/8"G	0.33 kg
A040351.02.00	15-80 bar	40 bar	14 bar/turn	40 l/min	500 bar	3/8"G	0.33 kg



Valvola di sequenza in linea Sequence valve

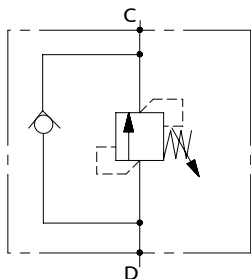

CURVE CARATTERISTICHE
PERFORMANCE CURVES

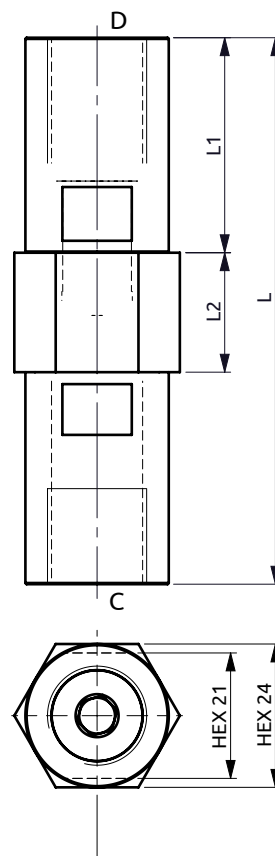
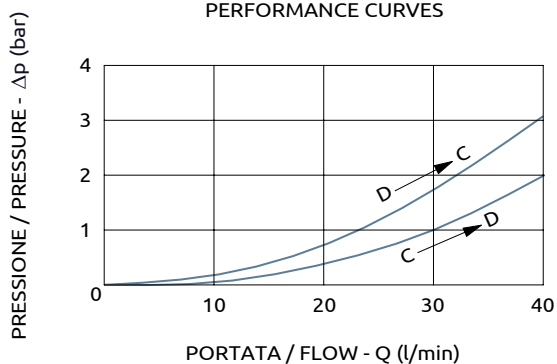

A040351.12.00	91.5	36	20
COD.	L	L1	L2

DESCRIZIONE	DESCRIPTION
Valvola di sequenza con taratura regolabile.	Sequence valve with adjustable setting.



Codice Ordinazione	Campo di Taratura	Taratura Standard	Incremento per giro	Portata Massima	Pressione Max	Dimensione Porte	Peso
Ordering Code	Pressure Range	Standard Setting	Pressure Increase	Max Flow	Max Pressure	Port Size	Weight
A040351.12.00	15-45 bar	40 bar	16 bar/turn	40 l/min	500 bar	3/8"G	0.3 kg



Valvola di sequenza in linea
Sequence valve

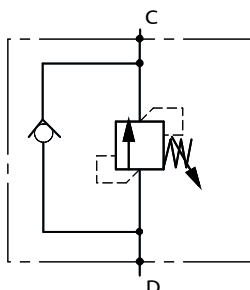

CURVE CARATTERISTICHE
PERFORMANCE CURVES

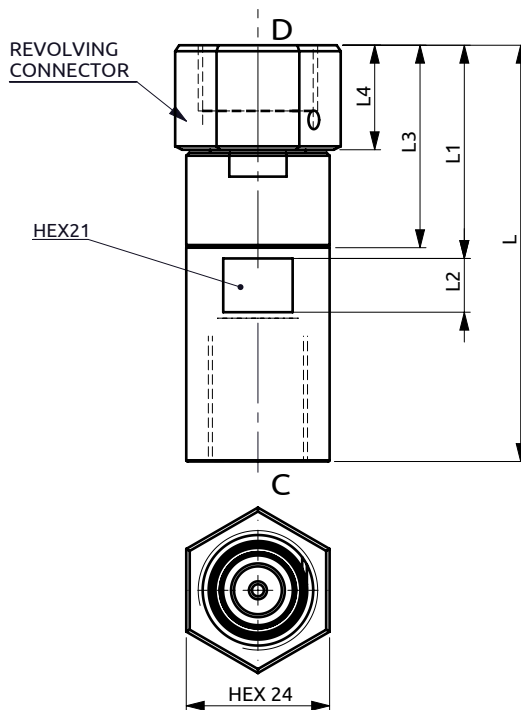
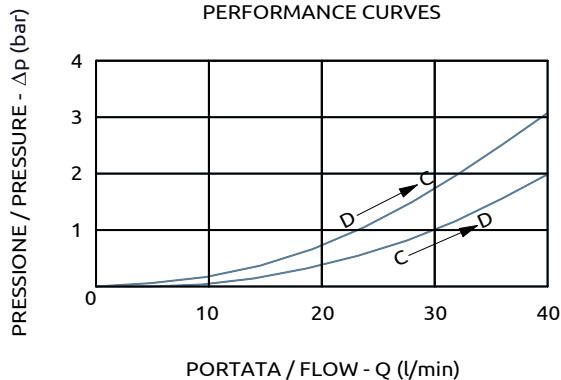

A040351.15.00	70.5	37	8	34.5	18
COD.	L	L1	L2	L3	L4



DESCRIZIONE	DESCRIPTION
Valvola di sequenza con taratura regolabile.	Sequence valve with adjustable setting.

Codice Ordinazione	Campo di Taratura	Taratura Standard	Incremento per giro	Portata Massima	Pressione Max	Dimensione Porte		Peso
Ordering Code	Pressure Range	Standard Setting	Pressure Increase	Max Flow	Max Pressure	Port Size		Weight
A040351.15.00	80-110 bar	100 bar	40 bar/turn	40 l/min	500 bar	C	3/8" G	0.35 kg
						D	M20x1.5	



Valvola di sequenza Sequence valve

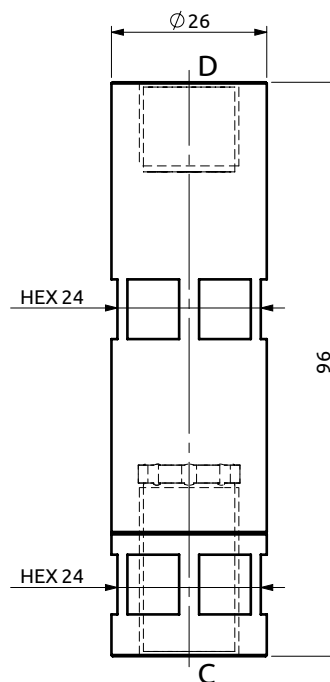
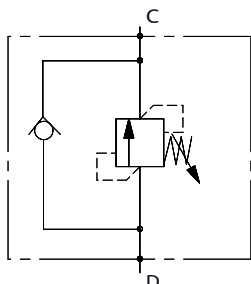

CURVE CARATTERISTICHE
PERFORMANCE CURVES

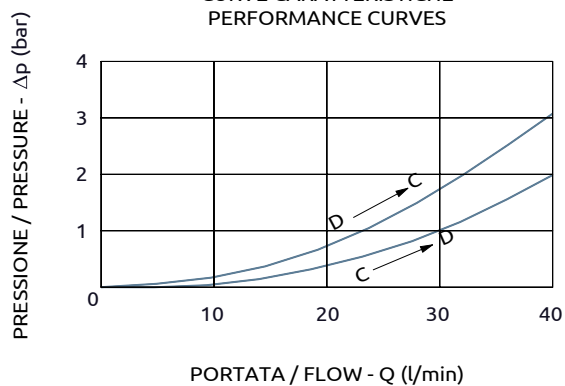

DESCRIZIONE	DESCRIPTION
Valvola di sequenza con taratura regolabile.	Sequence valve with adjustable setting.

Codice Ordinazione	Campo di Taratura	Taratura Standard	Incremento per giro	Portata Massima	Pressione Max	Dimensione Porte	Peso
Ordering Code	Pressure Range	Standard Setting	Pressure Increase	Max Flow	Max Pressure	Port Size	Weight
A040351.08.00	30-140 bar	30 bar	60 bar/turn	40 l/min	500 bar	3/8"G	0.28 kg
A040351.08.01	30-140 bar	120 bar	60 bar/turn	40 l/min	500 bar	3/8"G	0.28 kg
A040351.08.02	30-140 bar	50 bar	60 bar/turn	40 l/min	500 bar	3/8"G	0.28 kg



Valvola di sequenza in linea Sequence valve

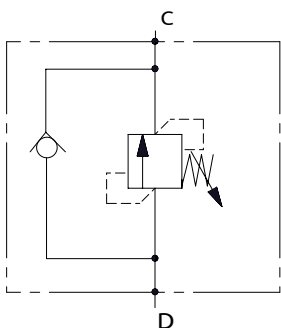

CURVE CARATTERISTICHE
PERFORMANCE CURVES

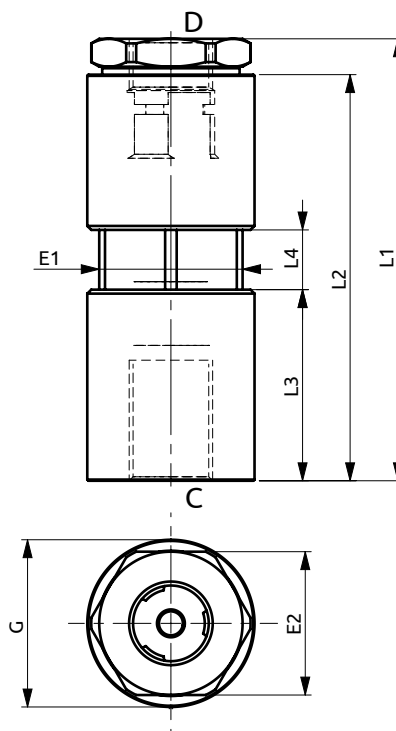
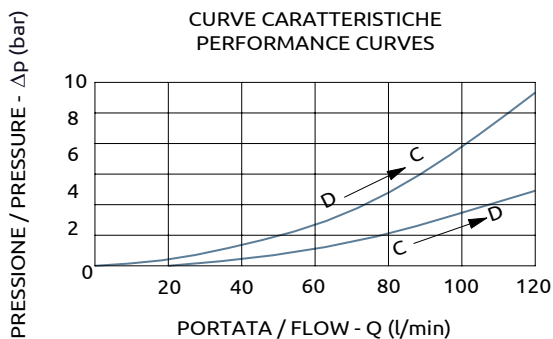

111	102	48	15	Ø42	HEX36	HEX36
L1	L2	L3	L4	G	E1	E2



DESCRIZIONE

Valvola di sequenza con taratura regolabile. Disponibile con due differenti attacchi d'estremità.

DESCRIPTION

Sequence valve with adjustable setting. Available with two different outlet ports.

Codice Ordinazione	Campo di Taratura	Taratura Standard	Incremento per giro	Portata Massima	Pressione Max	Dimensione Porte	Peso
Ordering Code	Pressure Range	Standard Setting	Pressure Increase	Max Flow	Max Pressure	Port Size	Weight
A040451.21.00	50-140 bar	50 bar	23 bar/turn	60 l/min	500 bar	1/2"G	0.95 kg
A040451.22.00	20-50 bar	20 bar	12 bar/turn	60 l/min	500 bar	1/2"G	0.95 kg
A040451.22.01	20-50 bar	50 bar	12 bar/turn	60 l/min	500 bar	1/2"G	0.95 kg



Valvola di sequenza Sequence valve

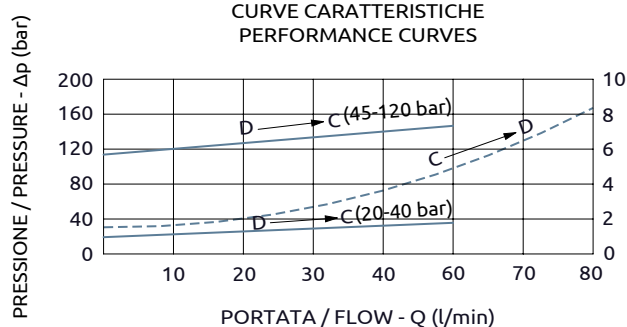
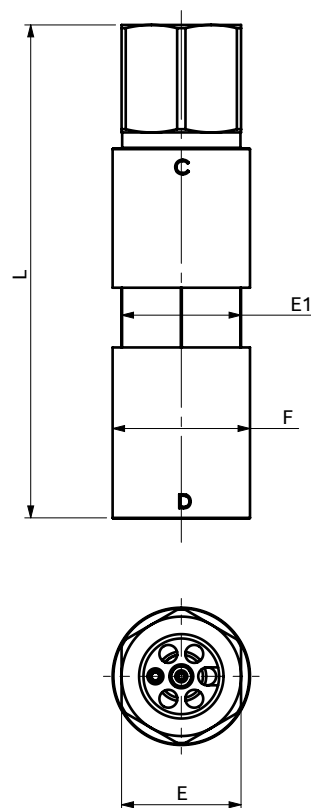
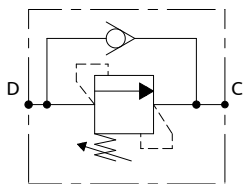

Corpo in acciaio / Steel body

A040451.03.00	124	Ø34.5	HEX30	HEX30
A040451.04.00	124	Ø34.5	HEX30	HEX30
COD.	L	F	E	E1



DESCRIZIONE	DESCRIPTION
Valvola di sequenza con taratura regolabile.	Sequence valve with adjustable setting.

Codice Ordinazione	Campo di Taratura	Taratura Standard	Incremento per Giro	Portata Massima	Pressione Max	Dimensione Porte		Peso
Ordering Code	Pressure Range	Standard Setting	Pressure Increase	Max Flow	Max Pressure	Port Size		Weight
A040451.03.00	20-40 bar	20 bar	~16 bar/turn	80 l/min	350 bar	D-C	1/2"G	0.6 kg
A040451.04.00	45-120 bar	120 bar	~47 bar/turn	80 l/min	350 bar	D-C	1/2"G	0.6 kg



Valvola di sequenza compensata Pressure compensated sequence valve

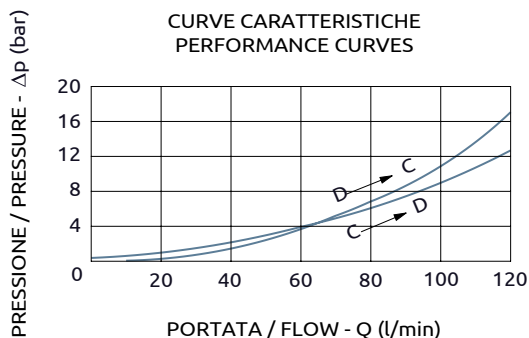
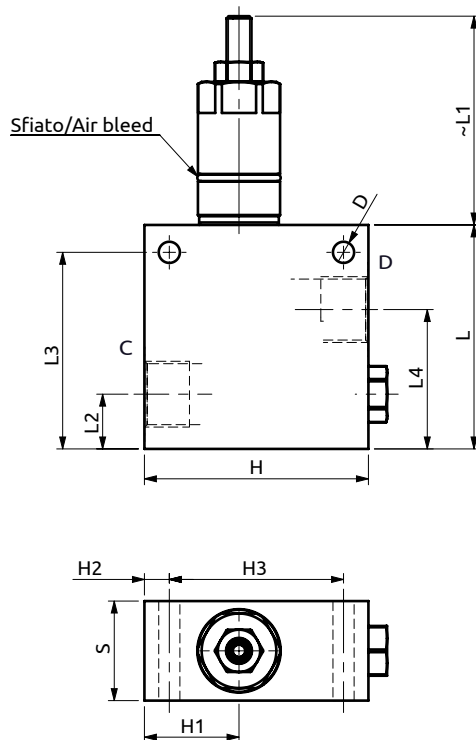
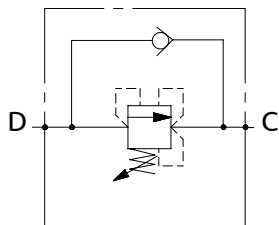

Corpo in alluminio / Aluminium body

B040602.01.00	90	~84	22	79	56	40	90	38	10	70	Ø8.5
COD.	L	L1	L2	L3	L4	S	H	H1	H2	H3	D



DESCRIZIONE	DESCRIPTION
Valvola di sequenza con taratura regolabile.	Sequence valve with adjustable setting.

Codice Ordinazione	Campo di Taratura	Taratura Standard	Incremento per Giro	Portata Massima	Pressione Max	Dimensione Porte	Peso
Ordering Code	Pressure Range	Standard Setting	Pressure Increase	Max Flow	Max Pressure	Port Size	Weight
B040602.01.00	50-220 bar	160 bar	90 bar/turn	120 l/min	300 bar	3/4"G	1.25 kg



Valvola di sequenza pilotata con otturatore cilindrico
Spool type sequence valve

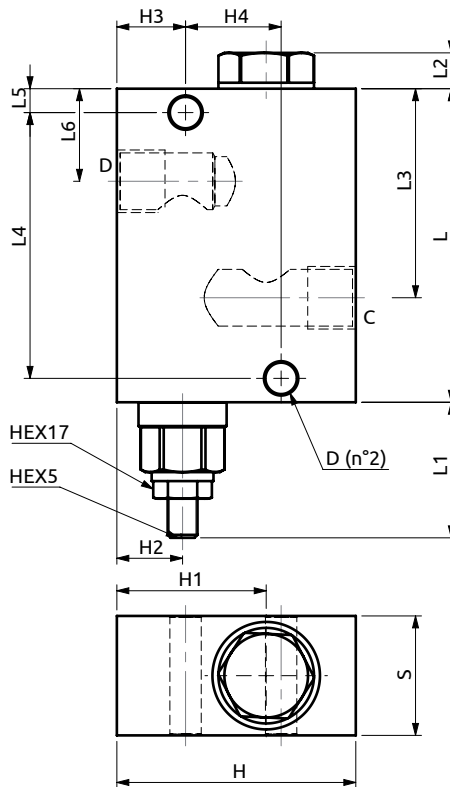
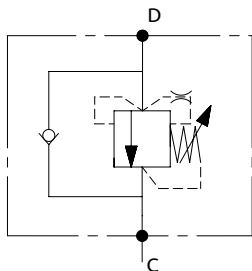

CURVE CARATTERISTICHE
 PERFORMANCE CURVES

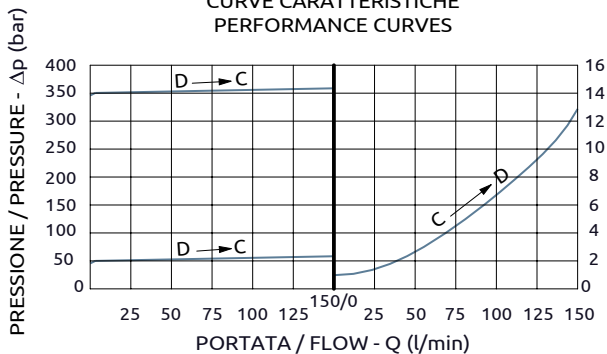

Corpo in alluminio / Aluminium body

105	~45.4	12	70	89	8	31	40	80	50	22	23	32	Ø10.5
L	L1	L2	L3	L4	L5	L6	S	H	H1	H2	H3	H4	D



DESCRIZIONE	DESCRIPTION
Valvola di sequenza con taratura regolabile.	Sequential valves with adjustable setting.

Ordine	Campo di Taratura	Taratura Standard	Portata Massima	Pressione Max	Dimensione Porte	Peso
Ordering Code	Pressure Range	Standard Setting	Max Flow	Max Pressure	Port Size	Weight
B040452.02.00	10-180 bar	50 bar	150 l/min	350 bar	1/2" G	1.1 kg
B040452.03.00	100-350 bar	350 bar	150 l/min	350 bar	1/2" G	1.1 kg



Valvola di sequenza in linea
Sequence valve

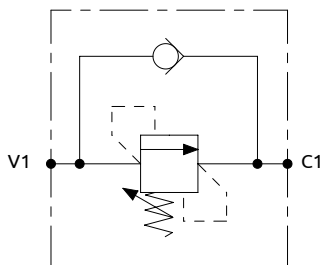

CURVE CARATTERISTICHE
PERFORMANCE CURVES

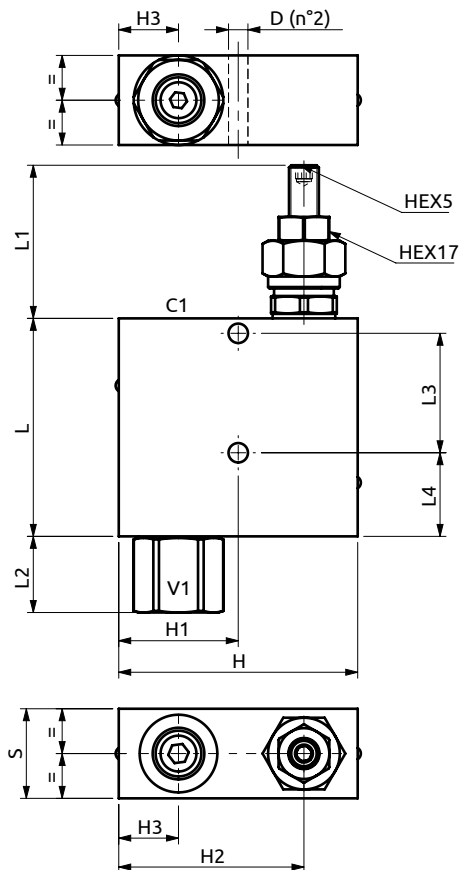
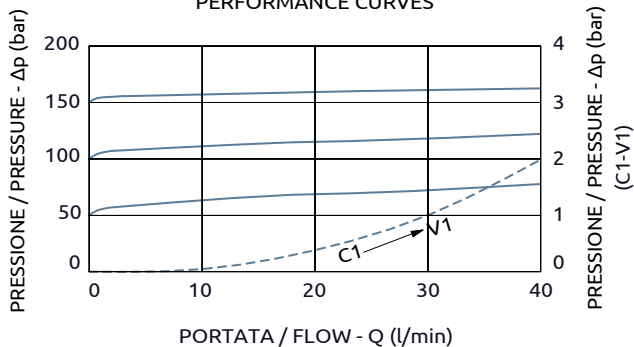

Corpo in alluminio / Aluminium body

B040352.02.00	73	~50	25.5	40	28	30	80	40	62	20	Ø6.5
COD.	L	L1	L2	L3	L4	S	H	H1	H2	H3	D



DESCRIZIONE	DESCRIPTION
Valvola di sequenza con taratura regolabile.	Sequence valve with adjustable setting.

Codice Ordinazione	Campo di Taratura	Taratura Standard	Incremento per Giro	Portata Massima	Pressione Max	Dimensione Porte	Peso
Ordering Code	Pressure Range	Standard Setting	Pressure Increase	Max Flow	Max Pressure	Port Size	Weight
B040352.02.00	50-150 bar	140 bar	25 bar/turn	40 l/min	350 bar	3/8"G	0.7 kg



Valvola di sequenza
Sequence valve

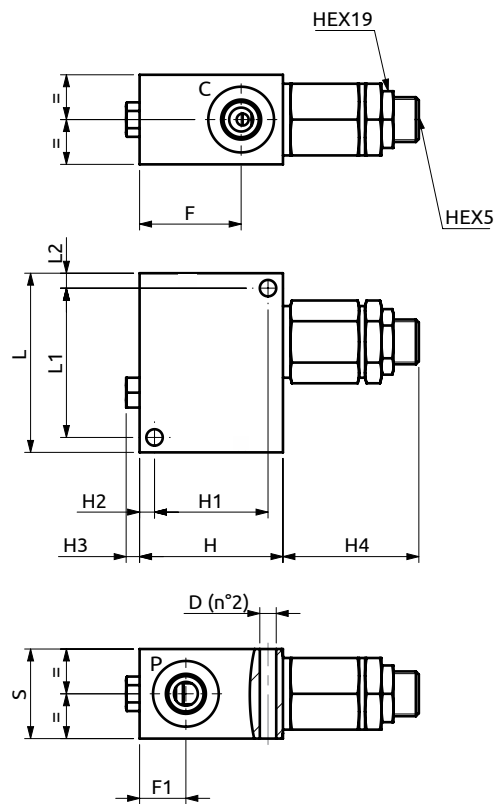
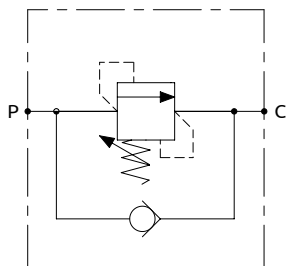

CURVE CARATTERISTICHE
PERFORMANCE CURVES

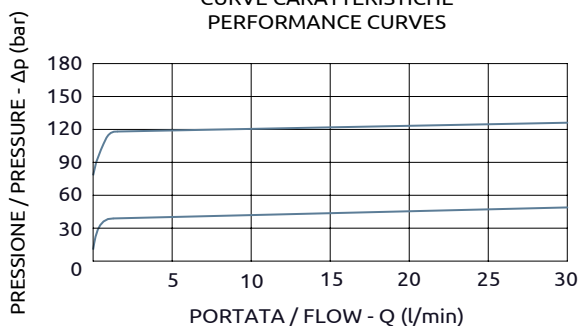

Corpo in acciaio / Steel body

A040252.01.00	60	50	5	30	48	38	5	4.5	45.5	34	15.5	Ø5.5
COD.	L	L1	L2	S	H	H1	H2	H3	H4	F	F1	D



DESCRIZIONE	DESCRIPTION
Valvola di sequenza con taratura regolabile.	Sequence valve with adjustable setting.

Ordine di codice	Campo di Taratura	Taratura Standard	Portata Massima	Pressione Max	Dimensione Porte	Peso
Ordering Code	Pressure Range	Standard Setting	Max Flow	Max Pressure	Port Size	Weight
A040252.01.00	25-135 bar	50 bar	30 l/min	350 bar	1/4"G	0.7 kg



Valvola di sequenza compensata
Pressure compensated sequence valve

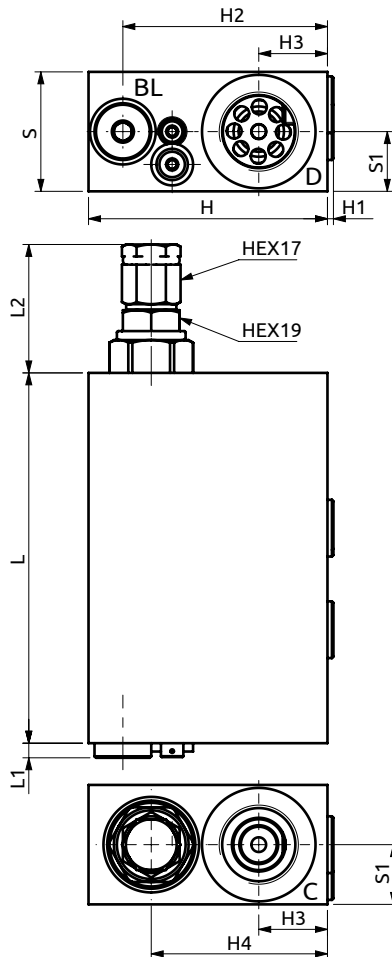
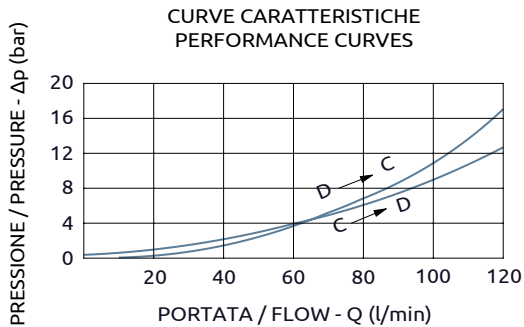
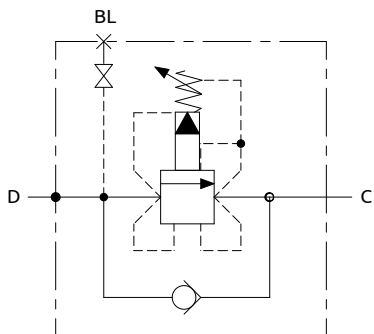

Corpo in acciaio / Steel body

A040602.03.00	124	5	43	40	20	80	2	68.5	23	59
COD.	L	L1	L2	S	S1	H	H1	H2	H3	H4



DESCRIZIONE	DESCRIPTION
Valvola di sequenza con taratura regolabile.	Sequence valve with adjustable setting.

Codice Ordinazione	Campo di Taratura	Taratura Standard	Incremento per Giro	Portata Massima	Pressione Max	Dimensione Porte		Peso
Ordering Code	Pressure Range	Standard Setting	Pressure Increase	Max Flow	Max Pressure	Port Size		Weight
A040602.03.00	50-240 bar	100 bar	45 bar/turn	120 l/min	350 bar	C, D	3/4"G	2.6 kg
						BL	1/4"G	



Valvola di sequenza pilotata
Pilot operated sequence valve

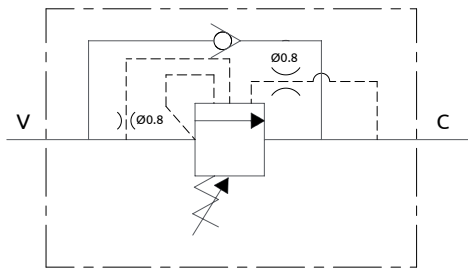

CURVE CARATTERISTICHE
PERFORMANCE CURVES

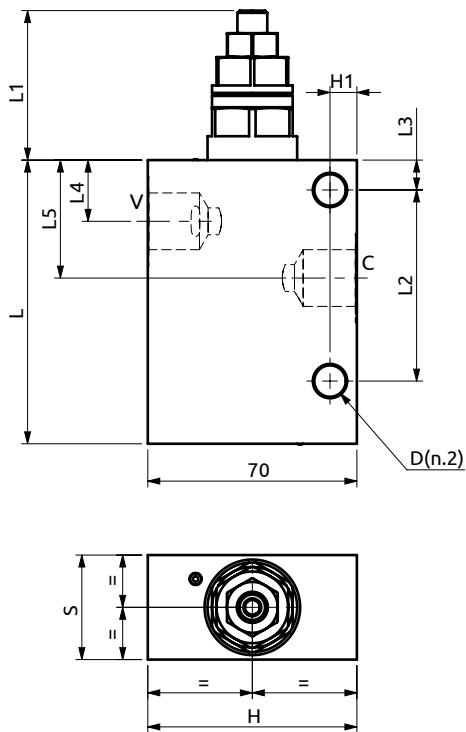
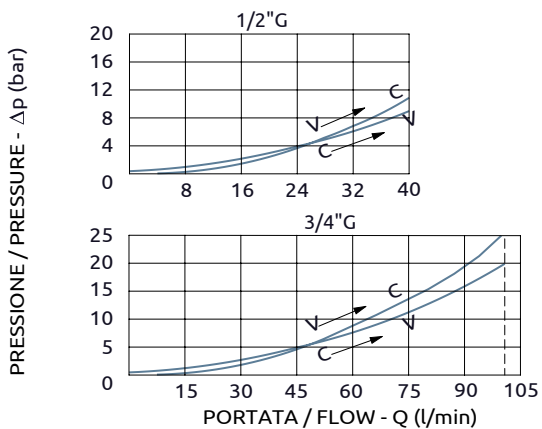

Corpo in alluminio / Aluminium body

B040402.02.00	95	51	64	10	20.5	39.5	35	70	9	Ø10.5
B040602.02.00	110	60	70	10	22	40.5	45	90	10	Ø10.5
COD.	L	L1	L2	L3	L4	L5	S	H	H1	D



DESCRIZIONE	DESCRIPTION
Valvola di sequenza con taratura regolabile.	Sequence valve with adjustable setting.

Codice Ordine	Campo di Taratura	Taratura Standard	Incremento per Giro	Portata Massima	Pressione Max	Dimensione Porte	Peso
Ordering Code	Pressure Range	Standard Setting	Pressure Increase	Max Flow	Max Pressure	Port Size	Weight
B040402.02.00	30-150 bar	120 bar	24 bar/turn	40 l/min	220 bar	1/2"G	0.8 kg
B040602.02.00	20-150 bar	120 bar	15 bar/turn	100 l/min	220 bar	3/4"G	1.5 kg



Valvola di sequenza a cartuccia Cartridge sequence valve

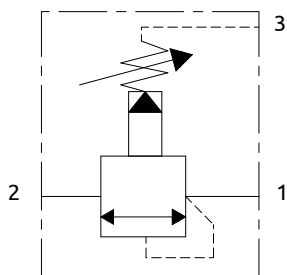

PRESSIONE / PRESSURE - Δp (bar)

CURVE CARATTERISTICHE
PERFORMANCE CURVES

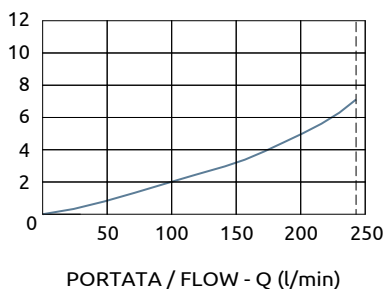

CODICE SEDE CAVITY CODE

HBS.48.M.03A (Pag. 99.05.03)

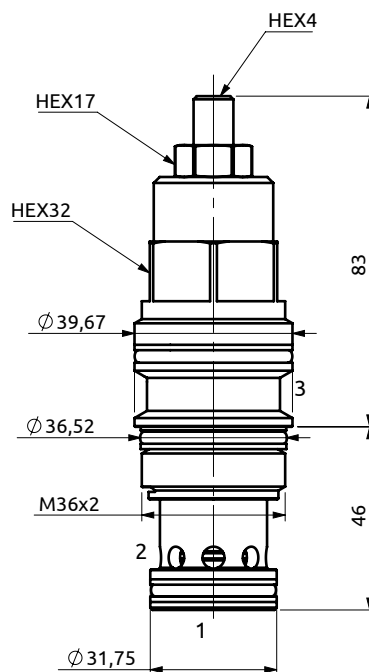

DESCRIZIONE

Valvola di sequenza pilotata con drenaggio esterno e taratura regolabile. Il flusso da 1 verso 2 è bloccato fino a quando non viene raggiunta la taratura impostata, indipendente dalla contropressione. Il drenaggio in 3 dev'essere collegato direttamente a scarico.

DESCRIPTION

Sequence valve pilot operated with adjustable setting. The flow from 1 to 2 is blocked until you reach the selected valve setting, independent of back-pressure. Drain at 3 has to be connected directly to tank.

COPPIA DI SERRAGGIO

INSTALLATION TORQUE

200-210 Nm

Codice Ordinazione	Campo di Taratura	Taratura Standard	Incremento per Giro	Portata Massima	Pressione Max	Peso
Ordering Code	Pressure Range	Standard Setting	Pressure Increase	Max Flow	Max Pressure	Weight
C044801.02.00	70-280 bar	250 bar	88 bar/turn	240 l/min	350 bar	0.62 kg