

Technical Information

Gear Pumps

Group 3

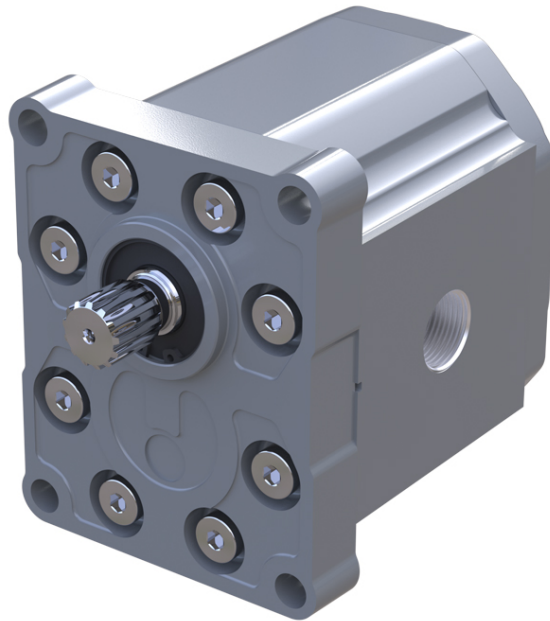

Revision history

Table of revisions

Date	Changed	Rev
October 2019	First edition	0101

Contents

General Information

Overview.....	4
Group 3 gear pumps' attributes.....	5
Pump displacements.....	5
Technical data for SNP3NN.....	6
Determination of nominal pump sizes.....	6

Product Coding

Model code.....	8
A Family.....	8
B Displacement.....	8
C Rotation.....	8
D Project version.....	8
E Mounting flange.....	8
F Drive gear.....	9
G Rear cover.....	9
H Inlet size; I Outlet size.....	10
J Ports positions & Special body.....	11
K Seals.....	11
L Screws.....	11
M Set valve.....	11
N Type mark.....	11
O Mark position.....	12

System Requirements

Pressure.....	13
Speed.....	13
Hydraulic fluids.....	14
Temperature and viscosity.....	14
Filtration.....	15
Filters.....	15
Selecting a filter.....	15
Reservoir.....	15
Line sizing.....	16
Pump drive.....	16
Pump drive data form.....	17
Pump Life.....	18
Sound levels.....	18

Pump Performance

Pump performance graphs.....	20
------------------------------	----

Product Options

Shaft, flange, and port configurations.....	23
Mounting flanges.....	25
Shaft options.....	25
Port configurations.....	26
Porting.....	27

Dimensions

SNP3NN - 01FA, 01DA, 01BA / SEP3NN - 01BA.....	29
SNP3NN - 02FA, 02DA and 02BA.....	30
SNP3NN - 03FB, 03BB.....	31
SNP3NN - 06DD, 06AA.....	32
SNP3NN and SEP3NN - 07SA, 07GA.....	33

General Information

Overview

The Danfoss Group 3 is a range of peak performance fixed-displacement gear pumps. Constructed of a high-strength extruded aluminum body with aluminum cover and flange, all pumps are pressure-balanced for exceptional efficiency.

SNP3NN 07SA

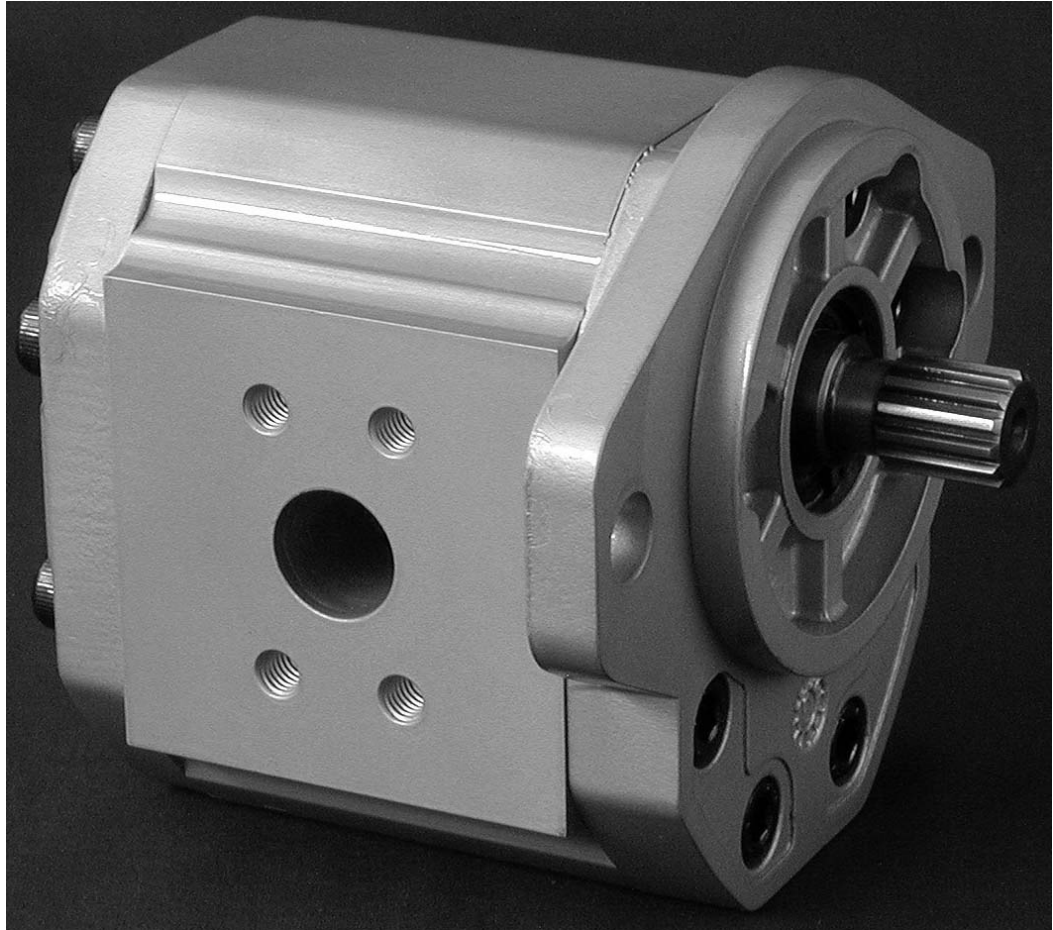

General Information

SNP3NN 01BA



Group 3 gear pumps' attributes

- Wide range of displacements from 22 to 90 cm³/rev [from 1.34 to 5.49 in³/rev]
- Continuous pressure rating up to 250 bar [3625 psi]
- Speeds up to 3000 min⁻¹ (rpm)
- SAE, DIN and European standard mounting flanges
- High quality case hardened steel gears
- Multiple pump configurations in combination with SNP1NN, SNP2NN and SNP3NN

Pump displacements

Quick reference chart for pump displacements vs. rated pressure

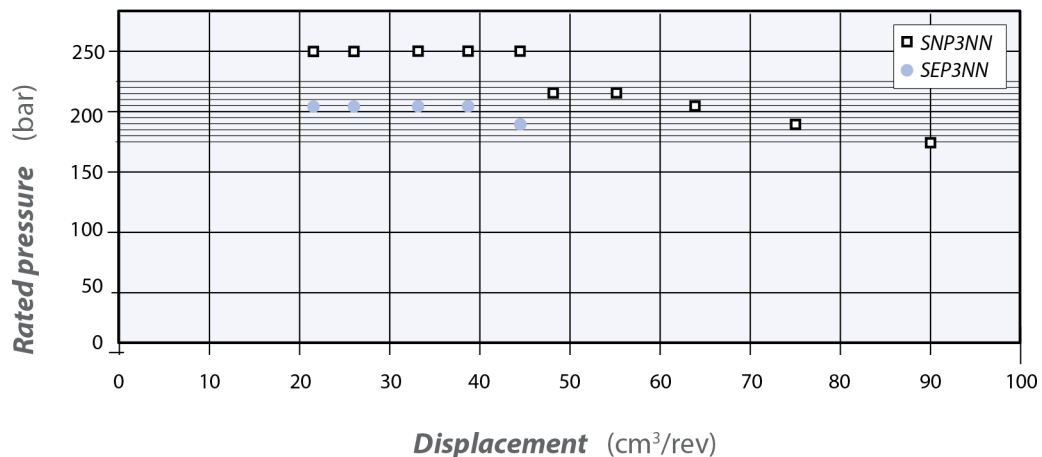

General Information

Technical data for SNP3NN

SNP3NN pump model		Frame size									
		022	026	033	038	044	048	055	063	075	090
Displacement	cm ³ /rev [in ³ /rev]	22.1 [1.35]	26.2 [1.60]	33.1 [2.02]	37.9 [2.32]	44.1 [2.69]	48.3 [2.93]	55.1 [3.36]	63.4 [3.87]	74.4 [4.54]	88.2 [5.38]
Peak pressure	bar [psi]	270 [3910]	270 [3910]	270 [3910]	270 [3910]	270 [3910]	250 [3625]	250 [3625]	230 [3350]	200 [2910]	170 [2465]
Rated pressure		250 [3625]	250 [3625]	250 [3625]	250 [3625]	250 [3625]	230 [3350]	230 [3350]	210 [3045]	180 [2610]	150 [2175]
Minimum speed	min ⁻¹ (rpm)	800	800	800	800	800	800	800	600	600	600
Maximum speed		3000	3000	3000	3000	3000	3000	2500	2500	2500	2500
Weight	kg [lb]	6.8 [15.0]	6.8 [15.0]	7.2 [15.8]	7.3 [16.1]	7.5 [16.5]	7.6 [16.8]	7.8 [17.3]	8.1 [17.9]	8.5 [18.7]	8.9 [19.6]
Moment of inertia of rotating components	x 10 ⁻⁶ kg·m ² [x 10 ⁻⁶ lb·ft ²]	198	216	246	267,2	294,2	312,2	342,3	378,3	426,4	486,5
Theoretical flow at maximum speed	l/min [US gal/min]	66.3 [17.5]	78.6 [20.8]	99.3 [26.2]	113.7 [30.0]	132.3 [35.0]	144.9 [38.3]	137.8 [36.4]	158.5 [41.8]	186 [49.1]	220.5 [58.3]

! Caution

The rated and peak pressure mentioned are for pumps with flanged ports only. When threaded ports are required a de-rated performance must be considered. To verify the compliance of an high pressure application with a threaded ports pump apply to a Danfoss representative.

Determination of nominal pump sizes

Use these formula to determine the nominal pump size for a specific application:

Based on SI units

Output flow: $Q = \frac{Vg \cdot n \cdot \eta_v}{1000} \text{ l/min}$

Input torque: $M = \frac{Vg \cdot \Delta p}{20 \cdot \pi \cdot \eta_m} \text{ N}\cdot\text{m}$

Input power: $P = \frac{M \cdot n}{9550} = \frac{Q \cdot \Delta p}{600 \cdot \eta_t} \text{ kW}$

Based on US units

$Q = \frac{Vg \cdot n \cdot \eta_v}{231} \text{ [US gal/min]}$

$M = \frac{Vg \cdot \Delta p}{2 \cdot \pi \cdot \eta_m} \text{ [lbf}\cdot\text{in]}$

$P = \frac{M \cdot n}{63.025} = \frac{Q \cdot \Delta p}{1714 \cdot \eta_t} \text{ [hp]}$

Vg =	Displacement per rev.	cm ³ /rev [in ³ /rev]
P _{HD} =	Outlet pressure	bar [psi]
P _{ND} =	Inlet pressure	bar [psi]
Δp =	P _{HD} - P _{ND}	bar [psi]
n =	Speed	min ⁻¹ (rpm)
η _v =	Volumetric efficiency	

General Information

$\eta_m =$	Mechanical (torque) efficiency	
$\eta_t =$	Overall efficiency ($\eta_v \cdot \eta_m$)	

Product Coding

Model code

A Family

A						B	C	D	E	F	G	H	I	J	K	L	M	N	O	
•	•	•	•	•	•	/											/			

SNP3NN	Std Gr3 Pump
---------------	--------------

B Displacement

A						B	C	D	E	F	G	H	I	J	K	L	M	N	O	
						/	•	•	•								/			

022	22,1 cc
026	26,2 cc
033	33,1 cc
038	37,9 cc
044	44,1 cc
048	48,3 cc
050	4,19 cc
055	50 cc special
063	55,2 cc
075	63,4 cc
090	74,4 cc
010	88,2cc

C Rotation

A						B	C	D	E	F	G	H	I	J	K	L	M	N	O
						/		•								/			

L	Left rotation
R	Right rotation

D Project version

A						B	C	D	E	F	G	H	I	J	K	L	M	N	O
						/		•								/			

N	Std Version of Project
----------	------------------------

E Mounting flange

A						B	C	D	E	F	G	H	I	J	K	L	M	N	O
						/			•	•						/			

Product Coding

Code	Description (Type of flange • Type of drive gear • Preferred ports for configuration)
01	European four bolt flange (98,4x128,1) - Pilot Ø50,8
02	European four bolt flange (98,4x137) - Pilot Ø50,8
03	European four bolt flange (114,3x149,5) - Pilot Ø60,3
06	German four bolt flange (102,0x145,0) - Pilot Ø105
07	SAE B-Pilot Ø101,6+2 holes
08	SAE C-Pilot Ø127+4 holes
09	SAE A-Pilot Ø82,55+2 holes
91	Outrigger bearing with European four bolt flange Pilot Ø50,8 -Taper 1:8 M14x1,5 key 4x7,5
D7	SAE B-Pilot Ø101,6+2 holes+special for double shaft seal - Special

F Drive gear

A	B	C	D	E	F	G	H	I	J	K	L	M	N	O
					• •									

AA	Taper 1:5-M16x1,5-Key 5
BA	Taper 1:8-M14x1,5-Key 4
BB	Taper 1:8-M16x1,5-Key 4,79
BC	Taper 1:8-5/8-18UNF-2A-Key 6,375
BD	Taper 1:8-M14x1,5-Key4 + thd hole M8 - Special
BP	Taper 1:8-5/8-18UNF-2A-Key 6,375 with NUT & WASHER (for SAE B flange)
CA	Tang 8xØ22,2 - Special
DA	DIN 5482 B22x19 L=24 (for flange 01)
DD	DIN 5482 B28x25 L28 (for flange 06)
FA	ParallelØ20-Key 5x5 L30 (for flange 01-02)
FB	Parallel Ø22-Key 5x5 L40 (for flange 03)
GA	ParallelØ22,225 x L25,4-Key 6,375x6,375 L25,4
GB	Parallel Ø22,225xL25,4-Key 6,375x6,375x25,4+thd hole:1/4-20UNC-2B
GC	Parallel Ø22,225xL25,4-Key 6,375x6,375x25,4+thd hole:5/16-18UNC-2B - Special
SA	SAE J498-13T-16/32-SAE B
SB	SAE J498-13T-16/32-SAE A (for flange 09)
RA	SAEJ498-14T-12/24-SAE C-4 bolt (for flange 08)
SH	SAE J498-15T-16/32-SAE B - Special

G Rear cover

A	B	C	D	E	F	G	H	I	J	K	L	M	N	O
						• •								

P1	Standard cover for pump
----	-------------------------

Product Coding

H Inlet size; I Outlet size

A				B	C	D	E	F	G	H	I	J	K	L	M	N	O	
			/							•	•	•	•			/		

A1	18,5x22,23x47,63x3/8-16UNC	
A3	25x26,19x52,37x3/8-16UNC	
A4	31x30,18x58,72x7/16-14UNC	
A5	37,5/27x35,71x69,85x1/2-13UNC	
B7	20x40xM6	
BA	18x55xM8	
BB	27x55xM8	
BC	36/27x55xM8	
C7	20x40xM8	
CA	27x51xM10	
CD	36x62xM10	
CZ	27x51xM10(2 Vert.Holes)	
G7	20x40x5/16-18UNC - Special	
GA	27x51x3/8-16UNC - Special	
E5	7/8-14UNF	
E6	1-1/16-12UN	
E8	1-5/16-12UN	
E9	1-5/8-12UN	
EA	1-7/8-12UN	
H8	M27x2-ISO6149	
H9	M33x2-ISO6149	
F5	BSP 3/4 GAS	
F6	BSP 1 GAS	
F7	BSP 1-1/4 GAS	
M5	25x52,37x26,19xM10	
M6	31x30,18x58,72xM10	
M7	37,5x35,71x69,85xM12	

Product Coding

MF	25x52,37x26,19xM8 deep12 Horiz	
MG	25/20x52,37x26,19xM10(=) - Special	
MH	31x30,18x58,72xM10 deep18 (=)	
MN	31x30,18x58,72xM10 deep12 (=)	
MR	37,5x35,71x69,85xM12 deep20 (=)	

J Ports positions & Special body

A	B	C	D	E	F	G	H	I	J	K	L	M	N	O
									•	•		/		

NN	Std from catalogue
ZZ	Port type Bx-Bx in the center of the body

K Seals

A	B	C	D	E	F	G	H	I	J	K	L	M	N	O
										•	/			

N	Standard NBR seals
D	NBR seals + VITON shaft seal with dust lip
I	Two opposite shaft seal

L Screws

A	B	C	D	E	F	G	H	I	J	K	L	M	N	O
											•	/		

N	Std burnished screws
B	Anticorrosion screws

M Set valve

A	B	C	D	E	F	G	H	I	J	K	L	M	N	O
												/	•	•

NNN	No valve
------------	----------

N Type mark

A	B	C	D	E	F	G	H	I	J	K	L	M	N	O
												/		•

N	Standard Danfoss Marking
A	Standard Danfoss Marking+Customer Code
Z	Without Marking

Product Coding

O Mark position

A					B				C	D	E	F	G	H	I	J	K	L		M	N	O	
				/															/				•

N	Std Marking position (on top)
A	Special Marking position on the bottom

System Requirements

Pressure

The inlet vacuum must be controlled in order to realize expected pump life and performance. The system design must meet inlet pressure requirements during all modes of operation. Expect lower inlet pressures during cold start. It should improve quickly as the fluid warms.

Max. continuous vacuum	bar abs. [in. Hg]	0.8 [23.6]
Max. intermittent vacuum		0.6 [17.7]
Max. pressure		3.0 [88.5]

Peak pressure is the highest intermittent pressure allowed. The relief valve overshoot (reaction time) determines peak pressure. It is assumed to occur for less than 100 ms. The accompanying illustration shows peak pressure in relation to rated pressure and reaction time (100 ms maximum).

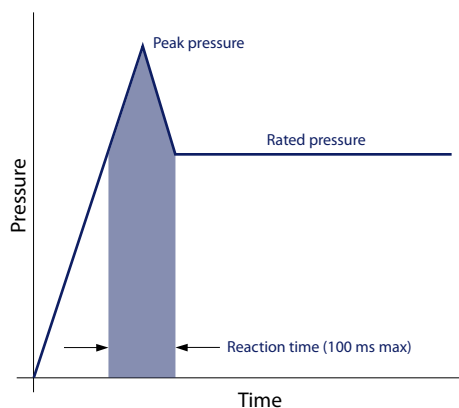

Rated pressure is the average, regularly occurring, operating pressure that should yield satisfactory product life. The maximum machine load demand determines rated pressure. For all systems, the load should move below this pressure.

System pressure is the differential of pressure between the outlet and inlet ports. It is a dominant operating variable affecting hydraulic unit life. High system pressure, resulting from high load, reduces expected life. System pressure must remain at, or below, rated pressure during normal operation to achieve expected life.

Speed

Maximum speed is the limit recommended by Danfoss for a particular gear pump when operating at rated pressure. It is the highest speed at which normal life can be expected.

The lower limit of operating speed is the **minimum speed**. It is the lowest speed at which normal life can be expected. The minimum speed increases as operating pressure increases. When operating under higher pressures, a higher minimum speed must be maintained, as illustrated here.

System Requirements

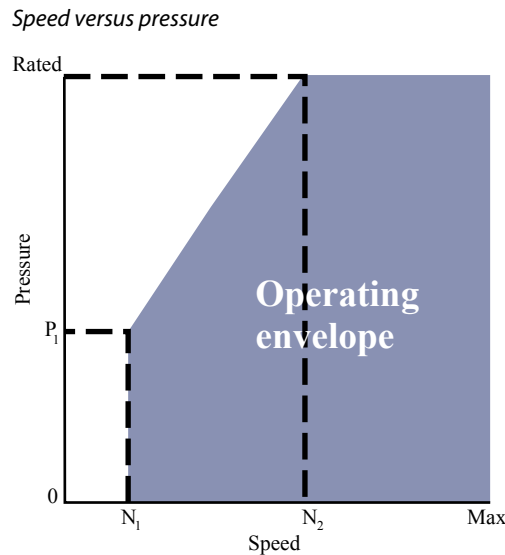

Where:

N_1 = Minimum speed at 100 bar

N_2 = Minimum speed at 180 bar

Hydraulic fluids

Ratings and data for SNP3NN and SHP3NN gear pumps are based on operating with premium hydraulic fluids containing oxidation, rust, and foam inhibitors. These fluids must possess good thermal and hydrolytic stability to prevent wear, erosion, and corrosion of internal components. They include:

- Hydraulic fluids following DIN 51524, part 2 (HLP) and part 3 (HVL) specifications
- API CD engine oils conforming to SAE J183
- M2C33F or G automatic transmission fluids
- Certain agricultural tractor fluids

Use only clean fluid in the pump and hydraulic circuit.

Caution

Never mix hydraulic fluids.

Temperature and viscosity

Temperature and viscosity requirements must be concurrently satisfied. Use petroleum / mineral-based fluids.

High temperature limits apply at the inlet port to the pump. The pump should run at or below the maximum continuous temperature. The peak temperature is based on material properties. Don't exceed it.

Cold oil, generally, doesn't affect the durability of pump components. It may affect the ability of oil to flow and transmit power. For this reason, keep the temperature at 16 °C [60 °F] above the pour point of the hydraulic fluid.

Minimum (cold start) temperature relates to the physical properties of component materials.

Minimum viscosity occurs only during brief occasions of maximum ambient temperature and severe duty cycle operation. You will encounter maximum viscosity only at cold start. During this condition, limit speeds until the system warms up. Size heat exchangers to keep the fluid within these limits. Test regularly to verify that these temperatures and viscosity limits aren't exceeded. For maximum unit efficiency and bearing life, keep the fluid viscosity in the recommended viscosity range.

System Requirements

Fluid viscosity

Maximum (cold start)	mm ² /s [SUS]	1000 [4600]
Recommended range		12-60 [66-290]
Minimum		10 [60]

Temperature

Minimum (cold start)	°C [°F]	-20 [-4]
Maximum continuous		80 [176]
Peak (intermittent)		90 [194]

Filtration

Filters

Use a filter that conforms to Class 22/18/13 of ISO 4406 (or better). It may be on the pump outlet (pressure filtration), inlet (suction filtration), or reservoir return (return-line filtration).

Selecting a filter

When selecting a filter, please consider:

- contaminant ingress rate (determined by factors such as the number of actuators used in the system)
- generation of contaminants in the system
- required fluid cleanliness
- desired maintenance interval
- filtration requirements of other system components

Measure filter efficiency with a Beta ratio (β_x). For:

- suction filtration, with controlled reservoir ingress, use a $\beta_{35-45} = 75$ filter
- return or pressure filtration, use a pressure filtration with an efficiency of $\beta_{10} = 75$

β_x ratio is a measure of filter efficiency defined by ISO 4572. It is the ratio of the number of particles greater than a given diameter ("x" in microns) upstream of the filter to the number of these particles downstream of the filter.

Fluid cleanliness level and β_x ratio

Fluid cleanliness level (per ISO 4406)	Class 22/18/13 or better
β_x ratio (suction filtration)	$\beta_{35-45} = 75$ and $\beta_{10} = 2$
β_x ratio (pressure or return filtration)	$\beta_{10} = 75$
Recommended inlet screen size	100-125 μ m [0.004-0.005 in]

The filtration requirements for each system are unique. Evaluate filtration system capacity by monitoring and testing prototypes.

Reservoir

The **reservoir** provides clean fluid, dissipates heat, removes entrained air, and allows fluid volume changes associated with fluid expansion and cylinder differential volumes. A correctly sized reservoir accommodates maximum volume changes during all system operating modes. It promotes deaeration of the fluid as it passes through, and accommodates a fluid dwell-time between 60 and 180 seconds, allowing entrained air to escape.

System Requirements

Minimum reservoir capacity depends on the volume required to cool and hold the oil from all retracted cylinders, allowing for expansion due to temperature changes. A fluid volume of 1 to 3 times the pump output flow (per minute) is satisfactory. The minimum reservoir capacity is 125% of the fluid volume.

Install the suction line above the bottom of the reservoir to take advantage of gravity separation and prevent large foreign particles from entering the line. Cover the line with a 100-125 micron screen. The pump should be below the lowest expected fluid level. Put the return-line below the lowest expected fluid level to allow discharge into the reservoir for maximum dwell and efficient deaeration. A baffle (or baffles) between the return and suction lines promotes deaeration and reduces fluid surges.

Line sizing

Choose pipe sizes that accommodate minimum fluid velocity to reduce system noise, pressure drops, and overheating. This maximizes system life and performance.

Design inlet piping that maintains continuous pump inlet pressure above 0.8 bar absolute during normal operation. The line velocity should not exceed the values in this table:

Maximum line velocity

Inlet	m/s [ft/sec]	2.5 [8.2]
Outlet		5.0 [16.4]
Return		3.0 [9.8]

Most systems use hydraulic oil containing 10% dissolved air by volume. Under high inlet vacuum conditions the oil releases bubbles. They collapse when subjected to pressure, resulting in cavitation, causing adjacent metal surfaces to erode. **Over-aeration** is the result of air leaks on the inlet side of the pump, and flow-line restrictions. These include inadequate pipe sizes, sharp bends, or elbow fittings, causing a reduction of flow line cross sectional area. This problem will not occur if inlet vacuum and rated speed requirements are maintained, and reservoir size and location are adequate.

Pump drive

Shaft options for Group 3 gear pumps include tapered, tang, splined, or parallel shafts. They are suitable for a wide range of direct and indirect drive applications for radial and thrust loads.

Plug-in drives, acceptable only with a splined shaft, can impose severe radial loads when the mating spline is rigidly supported. Increasing spline clearance does not alleviate this condition.

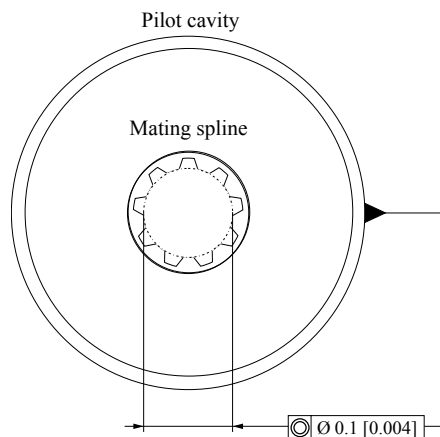

Use **plug-in drives** if the concentricity between the mating spline and pilot diameter is within 0.1 mm [0.004 in]. Lubricate the drive by flooding it with oil. A 3-piece coupling minimizes radial or thrust shaft loads.

System Requirements

! Caution

In order to avoid spline shaft damages it is recommended to use carburized and hardened steel couplings with 80-82 HRA surface hardness.

Allowable **radial shaft loads** are a function of the load position, load orientation, and operating pressure of the hydraulic pump. All external shaft loads have an effect on bearing life, and may affect pump performance.

In applications where external shaft loads can't be avoided, minimize the impact on the pump by optimizing the orientation and magnitude of the load. Use a tapered input shaft; don't use splined shafts for belt or gear drive applications. A spring-loaded belt tension-device is recommended for belt drive applications to avoid excessive tension. Avoid thrust loads in either direction.

Pump drive data form

Contact Danfoss if continuously applied external radial or thrust loads occur. Fill out this page and send the complete form to your Danfoss representative for an assistance in applying pumps with belt or gear drive. This illustration shows a pump with counterclockwise orientation:

Optimal radial load position

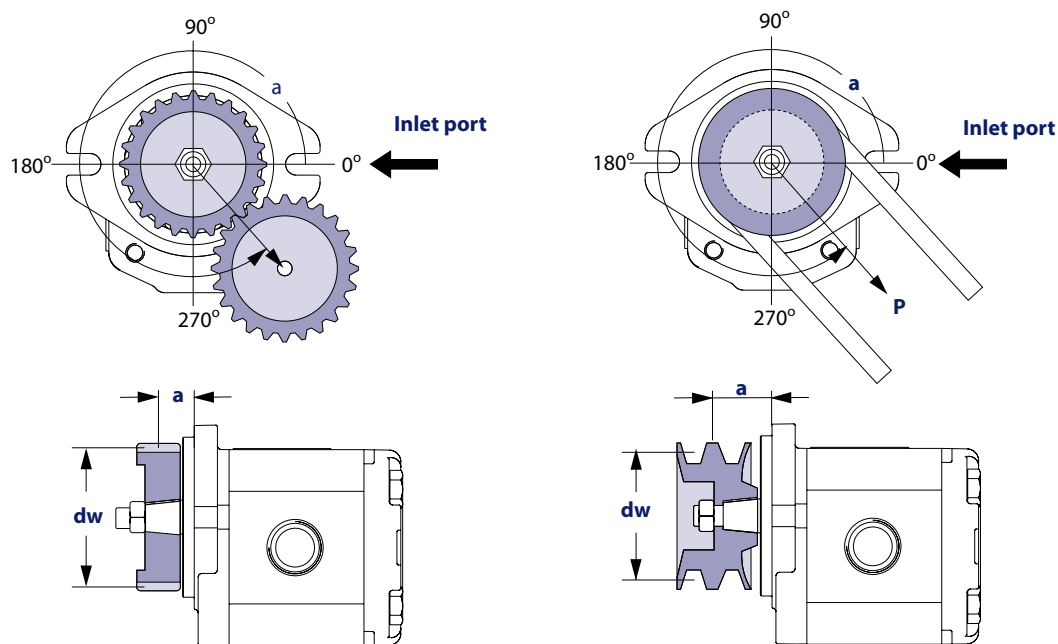

Application data

Item	Value	Unit
Pump displacement		cm ³ /rev [in ³ /rev]
Rated system pressure		bar psi
Relief valve setting		
Pump shaft rotation		left right
Pump minimum speed		min ⁻¹ (rpm)
Pump maximum speed		
Drive gear helix angle (gear drive only)		degree
Belt type (gear drive only)		V notch
Belt tension (gear drive only)	P	N lbf

System Requirements

Application data (continued)

Item	Value	Unit
Angular orientation of gear or belt to inlet port	α	degree
Pitch diameter of gear or pulley	dw	mm in
Distance from flange to center of gear or pulley	a	

Pump Life

Pump life is a function of speed, system pressure, and other system parameters (such as fluid quality and cleanliness).

All Danfoss gear pumps use hydrodynamic journal bearings that have an oil film maintained between the gear/shaft and bearing surfaces at all times. If the oil film is sufficiently sustained through proper system maintenance and operating within recommended limits, long life can be expected.

[B₁₀ life expectancy number is generally associated with rolling element bearings. It does not exist for hydrodynamic bearings.](#)

High pressure, resulting from high loads, impacts pump life. When submitting an application for review, provide machine duty cycle data that includes percentages of time at various loads and speeds. We strongly recommend a prototype testing program to verify operating parameters and their impact on life expectancy before finalizing any system design.

Sound levels

Fluid power systems are inherent generators of noise. As with many high power density devices, noise is an unwanted side affect. However, there are many techniques available to minimize noise from fluid power systems. To apply these methods effectively, it is necessary to understand how the noise is generated and how it reaches the listener. The noise energy can be transmitted away from its source as either fluid borne noise (pressure ripple) or as structure borne noise.

Pressure ripple is the result of the number of pumping elements (gear teeth) delivering oil to the outlet and the pump's ability to gradually change the volume of each pumping element from low to high pressure. In addition, the pressure ripple is affected by the compressibility of the oil as each pumping element discharges into the outlet of the pump. Pressure pulsations will travel along the hydraulic lines at the speed of sound (about 1400 m/s in oil) until affected by a change in the system such as an elbow fitting. Thus the pressure pulsation amplitude varies with overall line length and position.

Structure borne noise may be transmitted wherever the pump casing is connected to the rest of the system. The manner in which one circuit component responds to excitation depends on its size, form, and manner in which it is mounted or supported. Because of this excitation, a system line may actually have a greater noise level than the pump. To reduce this excitation, use flexible hoses in place of steel plumbing. If steel plumbing must be used, clamping of lines is recommended. To minimize other structure borne noise, use flexible (rubber) mounts.

The accompanying graph shows typical sound pressure levels for SNP3NN pumps (with SAE A flange, and spline shaft in plug in drive) measured in dB (A) at 1 m [3.28 ft] from the unit in a semi anechoic chamber. Anechoic levels can be estimated by subtracting 3 dB (A) from these values.

[Contact your Danfoss representative for assistance with system noise control.](#)

System Requirements

Sound levels graph

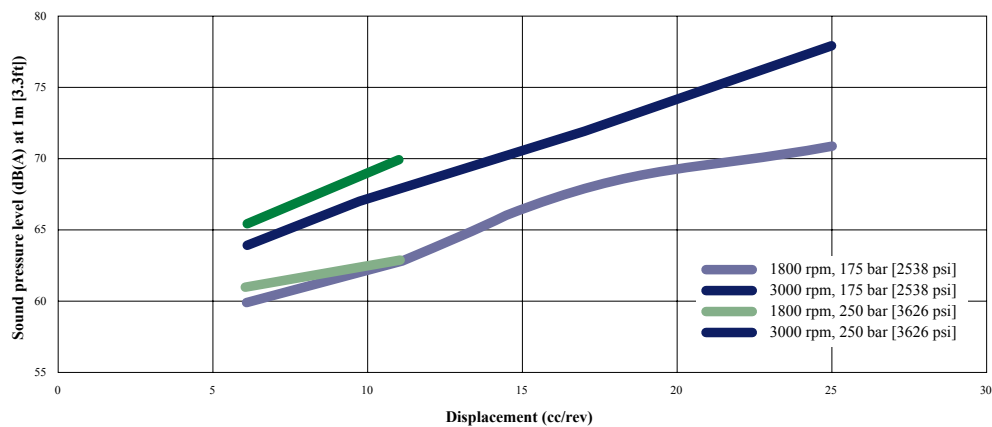

Pump Performance

Pump performance graphs

The following graphs provide typical output flow and input power for Group 3 pumps at various working pressures. Data were taken using ISO VG46 petroleum /mineral based fluid at 50 °C [122 °F] (viscosity = 28 mm²/s [132 SUS]).

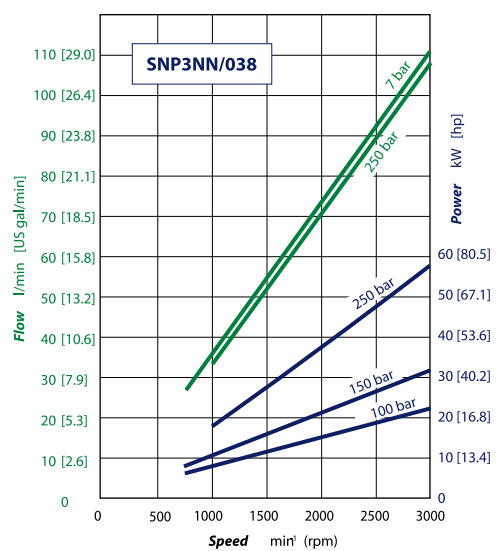
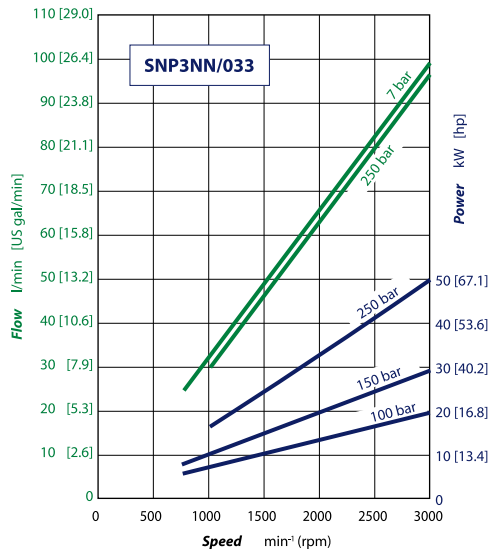
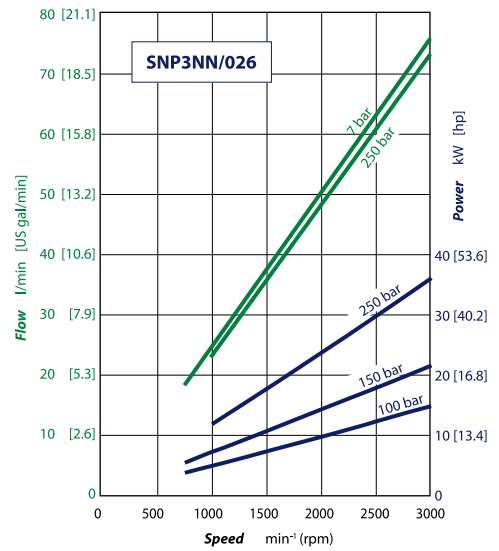
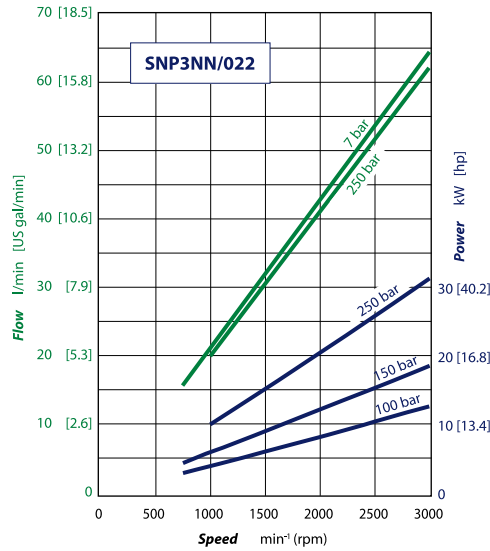

Pump Performance

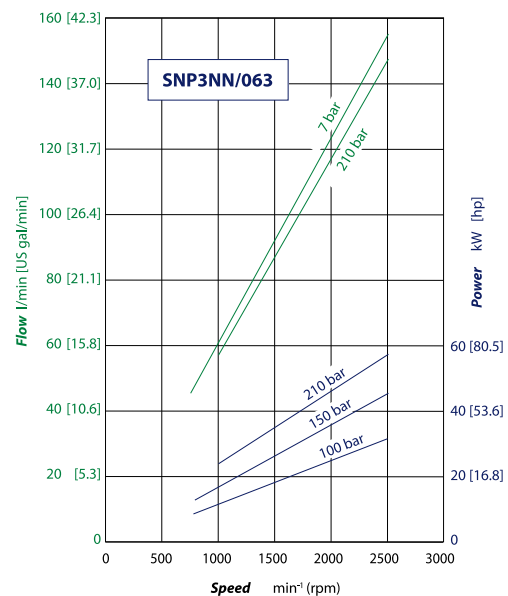
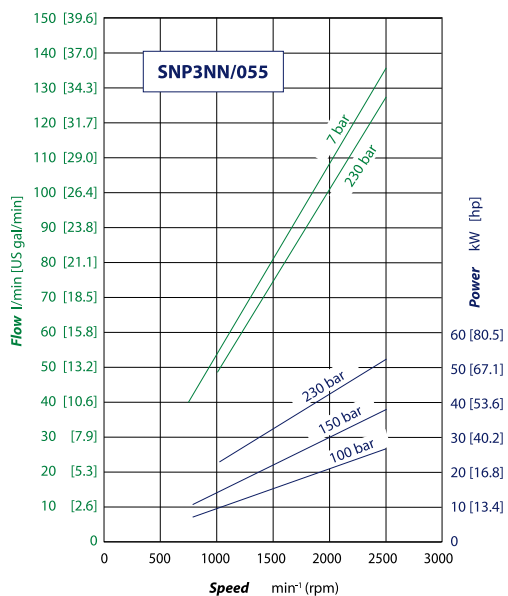
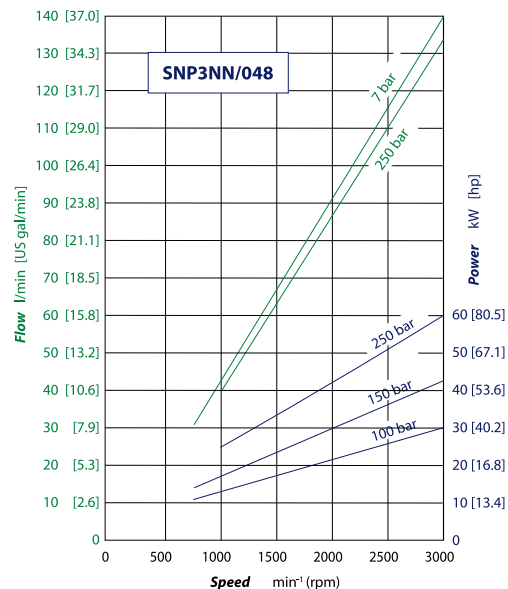
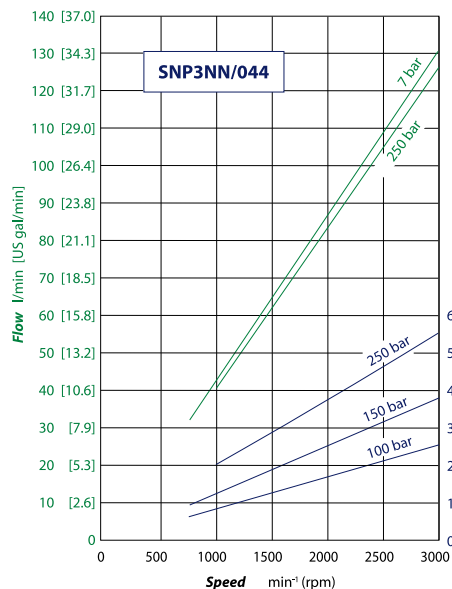

Pump Performance

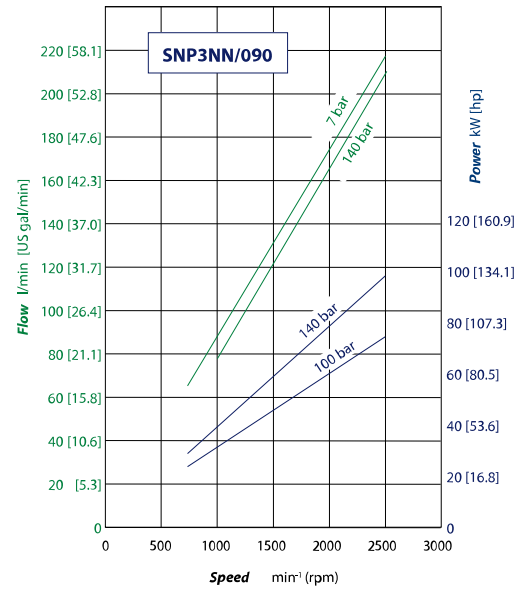
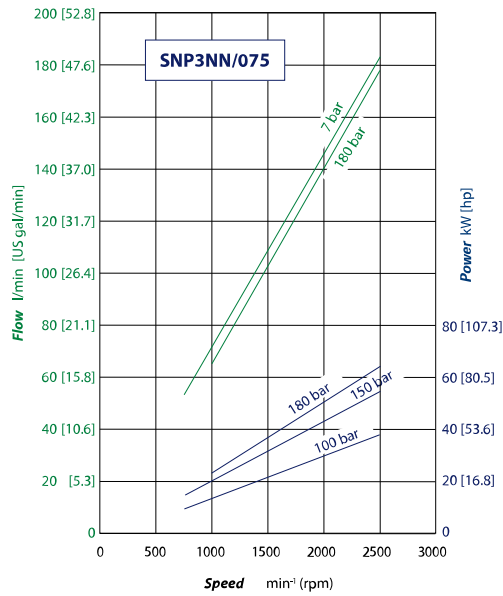

Product Options

Shaft, flange, and port configurations

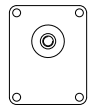
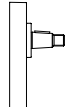
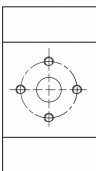
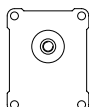
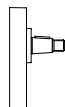
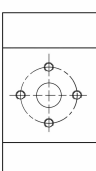
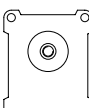
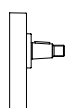
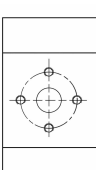
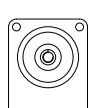
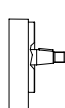
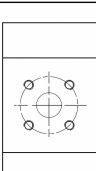
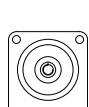
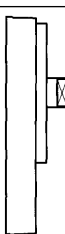
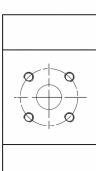
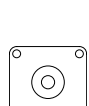
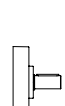
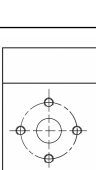
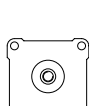
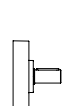
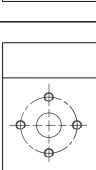
Motor	Code	Flange	Shaft	Port
SEP3NN SNP3NN	01BA	pilot Ø 50.8 mm [2.0 in] European 01, 4- bolt 	1:8 tapered 	European flanged port + pattern 
SNP3NN	02BA	pilot Ø 50.8 mm [2.0 in] European 02, 4- bolt 	1:8 tapered 	European flanged port + pattern 
SNP3NN	03BB	pilot Ø 60.3 mm [2.374 in] European 03, 4- bolt 	1:8 tapered 	European flanged port + pattern 
SNP3NN	06AA	pilot Ø 105 mm [4.133 in] German, 4-bolt 	1:5 tapered 	German std ports port X pattern 
SNP3NN	06CA	pilot Ø 105 mm [4.133 in] German, 4-bolt 	Tang 8 x Ø 22,2 	German std ports port X pattern 
SEP3NN SNP3NN	01FA	pilot Ø 50.8 mm [2.0 in] European 01 4- bolt 	Ø 20 mm [0.787 in] parallel 	European flanged port + pattern 
SNP3NN	02FA	pilot Ø 50.8 mm [2.0 in] European 02 4- bolt 	Ø 20 mm [0.787 in] parallel 	European flanged port + pattern 

Product Options

Motor	Code	Flange		Shaft		Port	
SNP3NN	03FB	pilot Ø 60.3 mm [2.374 in] European 03, 4-bolt		Ø 22 mm [0.866 in] parallel		European flanged port + pattern	
SEP3NN SNP3NN	07GA	pilot Ø 101.6 mm SAE B, 2-bolt		Ø 22.225 mm [0.875 in] parallel		Vertical four bolt flanged port	
SNP3NN	01DA	pilot Ø 50.8 mm [2.0 in] European 01, 4-bolt		Splined shaft 13T - m 1.60 DIN 5482 - B22 x 19		European flanged port + pattern	
SNP3NN	02DA	pilot Ø 50.8 mm [2.0 in] European 02, 4-bolt		Splined shaft 13T - m 1.60 DIN 5482 - B22 x 19		European flanged port + pattern	
SNP3NN	06DD	pilot Ø 105 mm [4.133 in] German 4-bolt		Splined shaft 15T - m 1.60 DIN 5482 - B28 x 25		German std ports port X pattern	
SNP3NN	07BC	pilot Ø 101.6 mm SAE B, 2-bolt		1:8 tapered - 5/8 - 18 UNF - 2A		Vertical four bolt flanged port	
SEP3NN SNP3NN	07SA	pilot Ø 101.6 mm SAE B, 2-bolt		Splined shaft SAE J498 13T - 16/32DP		Vertical four bolt flanged port	
SNP3NN	08RA	pilot Ø 127 mm [5.0 in] SAE C, 4-bolt		Splined shaft SAE J498 14T - 12/24DP		Vertical four bolt flanged port	
SNP3NN	09SB	pilot Ø 82.55 mm [3.25 in] SAE A, 2-bolt		Splined shaft SAE J498 13T - 16/32DP		Vertical four bolt flanged port	

Product Options

Motor	Code	Flange		Shaft		Port	
SNP3NN	91BA	Outrigger bearing with European four bolt flange Pilot Ø50,8		Taper 1:8 M14x1,5 key 4x7,5		European flanged port + pattern	
SNP3NN	D7SA	pilot Ø 101.6 mm [4.0 in] SAE B, 2-bolt, special for double shaft seal		Splined shaft SAE J498 13T - 16/32DP		Vertical four bolt flanged port	

Mounting flanges

Danfoss offers many types of industry standard mounting flanges. This table shows order codes for each available mounting flange and its intended use:

A	B	C	D	E	F	G	H	I	J	K	L	M	N	O
				•	•							/		

Code	Description
01	European 50.8 mm [2.0 in] 4-bolt
02	
03	European 60.3 mm [2.374 in] 4-bolt
06	German 105 mm [4.134 in] 4-bolt
07	SAE B 2-bolt
08	SAE C 4-bolt

Shaft options

Direction is viewed facing the shaft. Group 3 pumps are available with a variety of splined, parallel, and tapered shaft ends. Not all shaft styles are available with all flange styles.

A	B	C	D	E	F	G	H	I	J	K	L	M	N	O
					•	•						/		

Shaft		Mounting flange code with maximum torque in Nm [lb-in]								
Code	Description	01	02	03	06	07	08	09	D7	
AA	Taper 1:5-M16x1,5-Key 5				300					
BA	Taper 1:8-M14x1,5-Key 4	350	350							
BB	Taper 1:8-M16x1,5-Key 4,79			500						
BC	Taper 1:8-5/8-18UNF-2A-Key 6,375					300				
BD	Taper 1:8-M14x1,5-Key 4 + thd hole M8 - Special					300				
BP	Taper 1:8-5/8-18UNF-2A-Key 6,375 with NUT & WASHER (for SAE B flange)					300				
CA	Tang 8xØ22,2 - Special				90					
DA	DIN 5482 B22x19 L=24 (for flange 01)	290	290							

Product Options

Shaft		Mounting flange code with maximum torque in Nm [lb-in]							
Code	Description	01	02	03	06	07	08	09	D7
DD	DIN 5482 B28x25 L28 (for flange 06)				450				
FA	Parallel Ø20-Key 5x5 L30 (for flange 01-02)	210	210						
FB	Parallel Ø22-Key 5x5 L40 (for flange 03)			300					
GA	Parallel Ø22,225 x L25,4-Key 6,375x6,375 L25,4					230			
GB	Parallel Ø22,225xL25,4-Key 6,375x6,375x25,4+thd hole:1/4- 20UNC-2B					230			
GC	Parallel Ø22,225xL25,4-Key 6,375x6,375x25,4+thd hole:5/16- 18UNC-2B - Special					230			
SA	SAE J498-13T-16/32-SAE B					270			270
SB	SAE J498-13T-16/32-SAE A (for flange 09)							270	
RA	SAE J498-14T-12/24-SAE C-4 bolt (for flange 08)						400		
SH	SAE J498-15T-16/32-SAE B - Special					400			

Danfoss recommends mating splines conform to SAE J498 or DIN 5482. Danfoss external SAE splines have a flat root side fit with circular tooth thickness reduced by 0.127 mm [0.005 in] in respect to class 1 fit. Dimensions are modified to assure a clearance fit with the mating spline.

Caution

Shaft torque capability may limit allowable pressure. Torque ratings assume no external radial loading. Applied torque must not exceed these limits, regardless of stated pressure parameters. Maximum torque ratings are based on shaft torsional fatigue strength.

Port configurations

Various port configurations are available on Group 4 pumps. They include:

- SAE split flange ports
- European standard flanged ports
- Gas threaded ports (BSPP)

For a table of dimensions see [Porting](#).

Available port configurations

A	B	C	D	E	F	G	H	I	J	K	L	M	N	O
	/						•	•	•	•		/		

Code	Description
A4	31x30,18x58,72x7/16-14UNC
A5	37,5x35,71x69,85x1/2-13UNC
A6	50x42,88x77,77x1/2-13UNC

SAE flanged port

Product Options

CB	30x56xM10	Flanged port with thd holes in + pattern
CC	32x62xM10	
CD	36x62xM10	
CE	32x62xM12	
CF	38x72,5xM12	
CG	40x72,5xM12	
CH	45x72,5xM12	
CK	48x72,5xM12	
CL	56x92xM12	
F7	1-1/4 GAS	Threaded GAS (BSPP)
F8	1-1/2 GAS	
F9	1-3/4 GAS	
GE	32x62x7/16-14UNC	Flanged port with the holes in + pattern UN thread
GF	38x72,5x1/2-13UNC	
GK	48x72,5x1/2-13UNC	

Porting

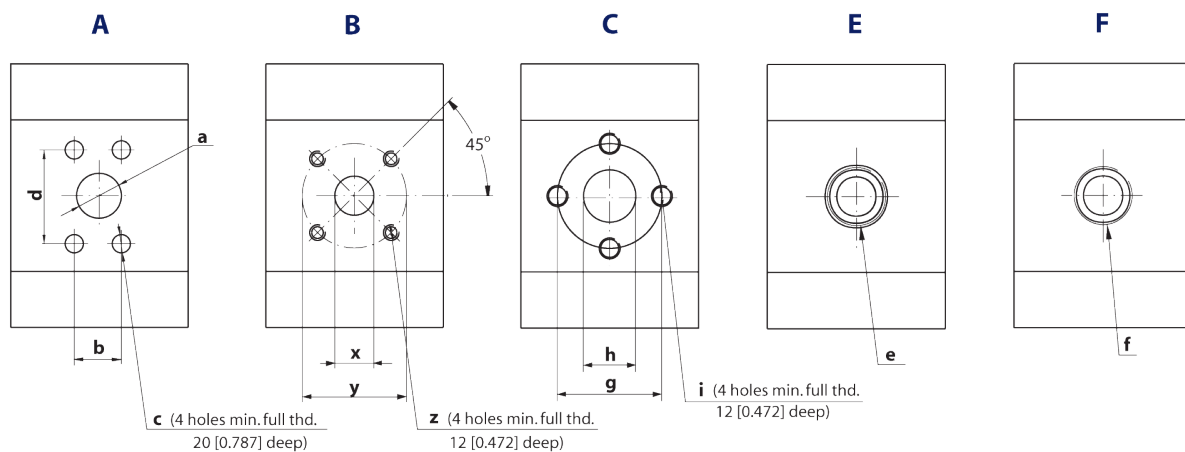

Product Options

Ports dimensions

Port type														
Dimensions			a	b	d	c	x	y	z	g	h	i	e	f
Type (displacement)	022	Inlet	25.4 [1.000]	26.19 [1.031]	52.37 [2.062]	3/8-16UNC-2B	27 [1.063]	55 [2.165]	M8	40 [1.575]	20 [0.787]	M8	15/16-12UN-2B	¾ Gas (BSPP)
		Outlet	19.1 [0.752]	22.23 [0.875]	47.63 [1.875]	3/8-16UNC-2B	18 [0.709]	55 [2.165]	M8	40 [1.575]	20 [0.787]	M8	11/16-12UN-2B	¾ Gas (BSPP)
	026	Inlet	25.4 [1.000]	26.19 [1.031]	52.37 [2.062]	3/8-16UNC-2B	27 [1.063]	55 [2.165]	M8	40 [1.575]	20 [0.787]	M8	15/16-12UN-2B	¾ Gas (BSPP)
		Outlet	19.1 [0.752]	22.23 [0.875]	47.63 [1.875]	3/8-16UNC-2B	18 [0.709]	55 [2.165]	M8	40 [1.575]	20 [0.787]	M8	11/16-12UN-2B	¾ Gas (BSPP)
	033	Inlet	31.8 [1.252]	30.18 [1.188]	58.72 [2.312]	7/16-14UNC-2B	27 [1.063]	55 [2.165]	M8	51 [2.008]	27 [1.063]	M10	15/8-12UN-2B	1 Gas (BSPP)
		Outlet	25.4 [1.000]	26.19 [1.031]	52.37 [2.062]	3/8-16UNC-2B	18 [0.709]	55 [2.165]	M8	40 [1.575]	20 [0.787]	M8	15/16-12UN-2B	¾ Gas (BSPP)
	038	Inlet	31.8 [1.252]	30.18 [1.188]	58.72 [2.312]	7/16-14UNC-2B	27 [1.063]	55 [2.165]	M8	51 [2.008]	27 [1.063]	M10	15/8-12UN-2B	1 Gas (BSPP)
		Outlet	25.4 [1.000]	26.19 [1.031]	52.37 [2.062]	3/8-16UNC-2B	18 [0.709]	55 [2.165]	M8	40 [1.575]	20 [0.787]	M8	15/16-12UN-2B	¾ Gas (BSPP)
	044	Inlet	31.8 [1.252]	30.18 [1.188]	58.72 [2.312]	7/16-14UNC-2B	27 [1.063]	55 [2.165]	M8	51 [2.008]	27 [1.063]	M10	15/8-12UN-2B	1 Gas (BSPP)
		Outlet	25.4 [1.000]	26.19 [1.031]	52.37 [2.062]	3/8-16UNC-2B	18 [0.709]	55 [2.165]	M8	51 [2.008]	27 [1.063]	M10	15/16-12UN-2B	1 Gas (BSPP)
	048	Inlet	31.8 [1.252]	30.18 [1.188]	58.72 [2.312]	7/16-14UNC-2B	27 [1.063]	55 [2.165]	M8	51 [2.008]	27 [1.063]	M10	15/8-12UN-2B	1 Gas (BSPP)
		Outlet	25.4 [1.000]	26.19 [1.031]	52.37 [2.062]	3/8-16UNC-2B	18 [0.709]	55 [2.165]	M8	51 [2.008]	27 [1.063]	M10	15/16-12UN-2B	1 Gas (BSPP)
	055	Inlet	38.1 [1.500]	35.71 [1.406]	69.85 [2.750]	½-13UNC-2B	27 [1.063]	55 [2.165]	M8	51 [2.008]	27 [1.063]	M10	17/8-12UN-2B	1 Gas (BSPP)
		Outlet	31.8 [1.252]	30.18 [1.188]	58.72 [2.312]	7/16-14UNC-2B	18 [0.709]	55 [2.165]	M8	51 [2.008]	27 [1.063]	M10	15/8-12UN-2B	1 Gas (BSPP)
	063	Inlet	38.1 [1.500]	35.71 [1.406]	69.85 [2.750]	½-13UNC-2B	36 [1.417]	55 [2.165]	M8	62 [2.441]	36 [1.417]	M10	17/8-12UN-2B	1¼ Gas (BSPP)
		Outlet	31.8 [1.252]	30.18 [1.188]	58.72 [2.312]	7/16-14UNC-2B	27 [1.063]	55 [2.165]	M8	51 [2.008]	27 [1.063]	M10	15/8-12UN-2B	1 Gas (BSPP)
	075	Inlet	38.1 [1.500]	35.71 [1.406]	69.85 [2.750]	½-13UNC-2B	36 [1.417]	55 [2.165]	M8	62 [2.441]	36 [1.417]	M10	17/8-12UN-2B	1¼ Gas (BSPP)
		Outlet	31.8 [1.252]	30.18 [1.188]	58.72 [2.312]	7/16-14UNC-2B	27 [1.063]	55 [2.165]	M8	51 [2.008]	27 [1.063]	M10	15/8-12UN-2B	1 Gas (BSPP)
	090	Inlet	38.1 [1.500]	35.71 [1.406]	69.85 [2.750]	½-13UNC-2B	36 [1.417]	55 [2.165]	M8	62 [2.441]	36 [1.417]	M10	17/8-12UN-2B	1¼ Gas (BSPP)
		Outlet	31.8 [1.252]	30.18 [1.188]	58.72 [2.312]	7/16-14UNC-2B	27 [1.063]	55 [2.165]	M8	51 [2.008]	27 [1.063]	M10	15/8-12UN-2B	1 Gas (BSPP)

Dimensions

SNP3NN - 02FA,02DA and 02BA

This drawing shows the standard porting for 02FA, 02DA and 02BA.

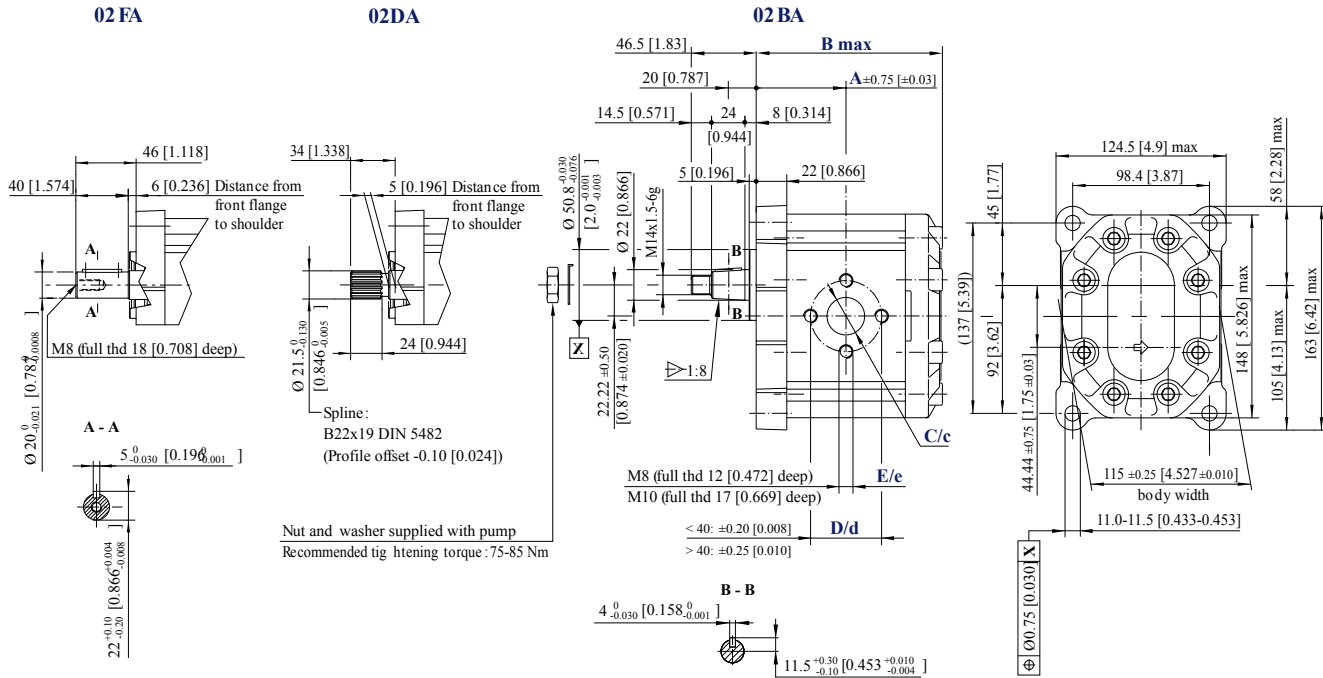

SNP3NN - 02FA, 02DA AND 02BA dimensions

Frame size		022	026	033	038	044	048	055	063	075	090	
Dimension	A	63 [2.480]	64.5 [2.539]	67 [2.637]	68.8 [2.708]	71 [2.795]	72.5 [2.854]	75 [2.952]	78 [3.07]	82 [3.228]	87 [3.425]	
	B	132.5 [5.216]	135.5 [5.334]	140.5 [5.531]	144 [5.669]	148.5 [5.846]	151.5 [5.964]	156.5 [6.161]	162.5 [6.397]	170.5 [6.712]	180.5 [7.106]	
Inlet	C	20 [0.787]		27 [1.063]			36 [1.417]					
	D	40 [1.575]		51 [2.007]			62 [2.441]					
	E	M8		M10								
Outlet	c	20 [0.787]				27 [1.063]						
	d	40 [1.575]				51 [2.001]						
	e	M8				M10						

Model code examples and maximum shaft torque

Flange/drive gear configuration	Model code example	Maximum shaft torque N•m [lb•in]
02FA	SNP3NN/044RN02FAP1CACANNNN/NNNNN	210 [1858]
02DA	SNP3NN/033RN02DAP1CAC7NNNN/NNNNN	290 [2566]
02BA	SNP3NN/026LN02BAP1C7C7NNNN/NNNNN	350 [3097]

For further details on ordering, see [Model code](#) on page 8.

Dimensions

SNP3NN - 06DD, 06AA

This drawing shows the standard porting for 06DD and 06AA.

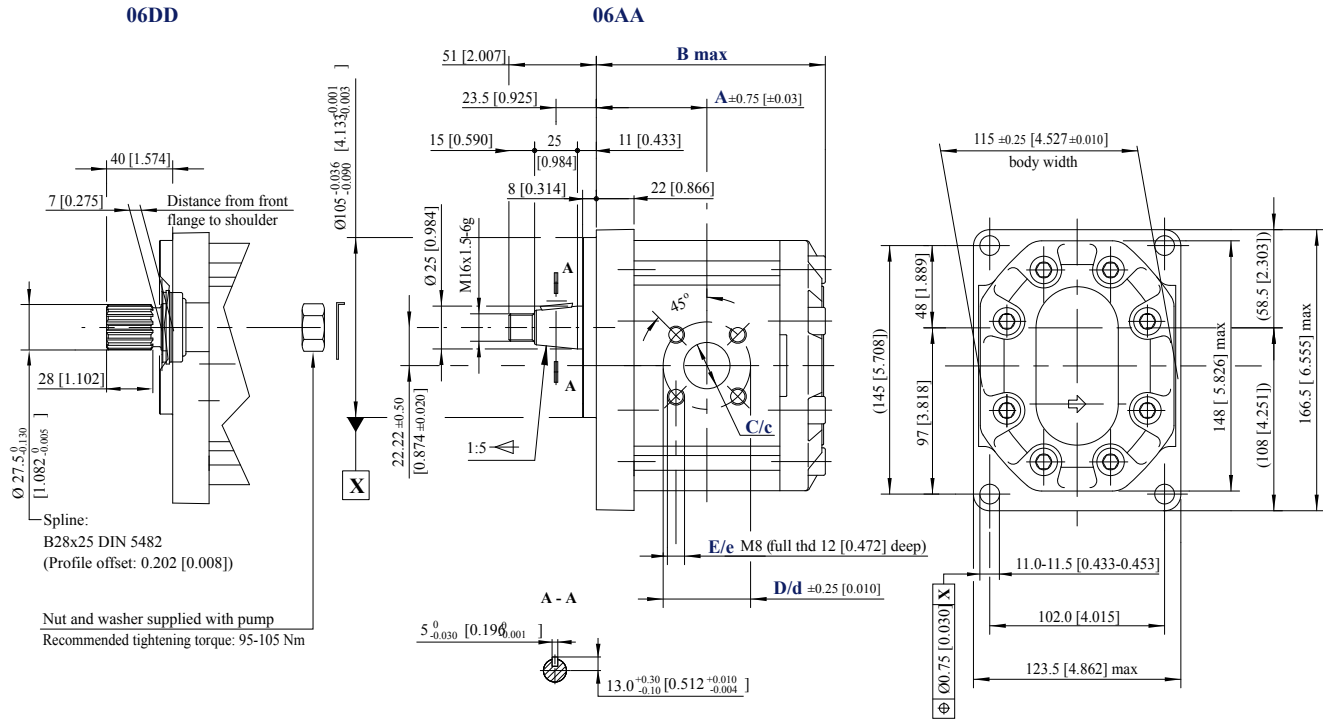

SNP3NN – 06DD and 06AA dimensions

Type (displacement)		022	026	033	038	044	048	055	063	075	090	
Dimension	A	63.0 [2.480]	64.5 [2.539]	67.0 [2.637]	68.8 [2.708]	71.0 [2.795]	72.5 [2.854]	75.0 [2.952]	78.0 [3.070]	82.0 [3.228]	87.0 [3.425]	
	B	132.5 [5.216]	135.5 [5.334]	140.5 [5.531]	144.0 [5.669]	148.5 [5.846]	151.5 [5.964]	156.5 [6.161]	162.5 [6.397]	170.5 [6.712]	180.5 [7.106]	
Inlet	C	27 [1.063]							36 [1.417]			
	D	55 [2.165]										
	E	M8										
Outlet	c	18 [0.708]							27 [1.063]			
	d	55 [2.165]										
	e	M8										

Model code examples and maximum shaft torque

Flange/drive gear configuration	Model code example	Maximum shaft torque N·m [lb·in]
06DD	SNP3NN/044RN06DDP1BBBANNNN/NNNNN	450 [3982]
06AA	SNP3NN/026LN06AAP1BBBANNNN/NNNNN	300 [2655]

For further details on ordering, see [Model code](#) on page 8.

Dimensions

SNP3NN and SEP3NN - 07SA, 07GA

The drawing shows the SNP3NN standard porting for 07SA and 07GA. The same configurations are available for the SEP3NN.

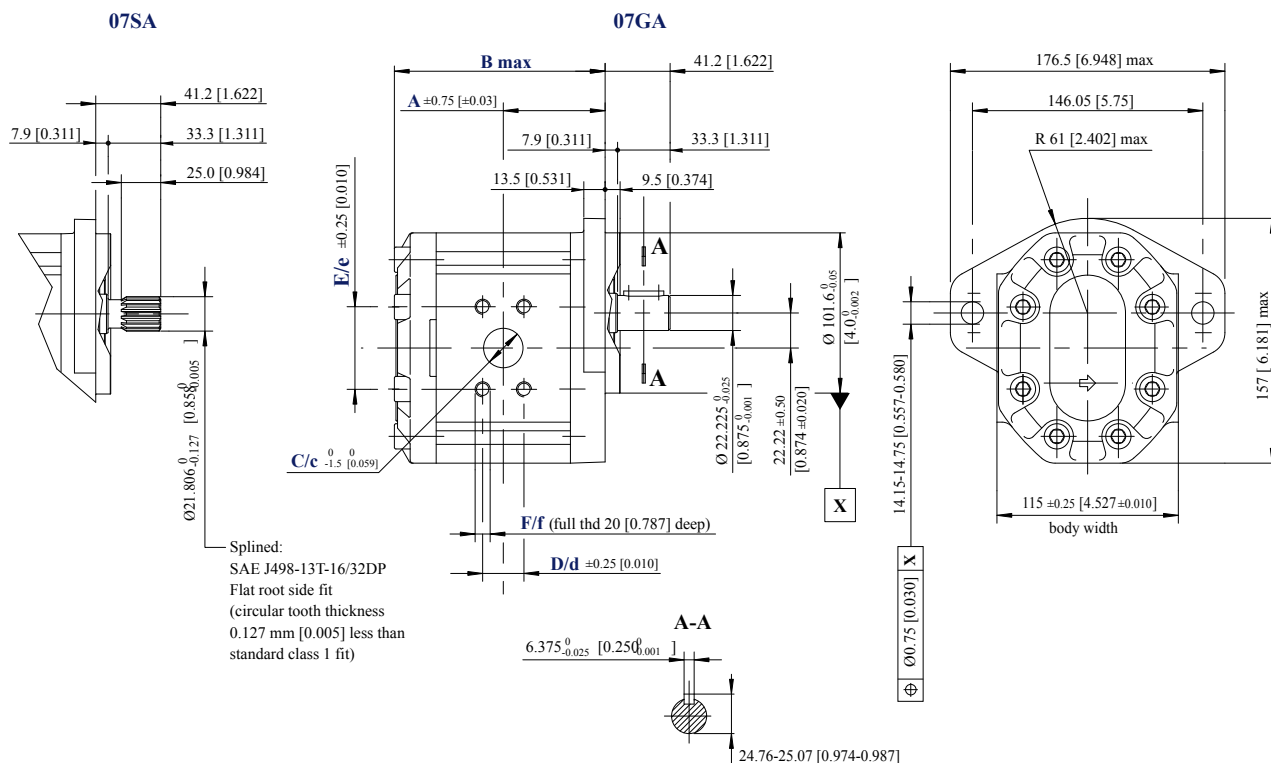

The SEP3NN overall length is 12 mm [0.472 in] less than the SNP3NN for the whole range of displacements (22.1 to 44.1 cm³/rev [1.35 to 2.69 in³/rev]).

SNP3NN, SEP3NN – 07SA and 07GA dimensions

Type (displacement)		022	026	033	038	044	048	055	063	075	090
Dimension	A	63.0 [2.480]	64.5 [2.539]	67.0 [2.637]	68.8 [2.708]	71.0 [2.795]	72.5 [2.854]	75.0 [2.952]	78.0 [3.070]	82.0 [3.228]	87.0 [3.425]
	B	132.5 [5.216]	135.5 [5.334]	140.5 [5.531]	144.0 [5.669]	148.5 [5.846]	151.5 [5.964]	156.5 [6.161]	162.5 [6.397]	170.5 [6.712]	180.5 [7.106]
Inlet	C	25.4 [1]		31.8 [1.251]			38.1 [1.5]				
	D	26.19 [1.031]		30.18 [1.188]			35.71 [1.405]				
	E	52.37 [2.061]		58.72 [2.311]			69.85 [2.75]				
	F	3/8-16UNC-2B		7/16-14UNC-2B			½-13UNC-2B				
Outlet	c	19.1 [0.751]		25.4 [1.0]			31.8 [1.251]				
	d	22.23 [0.875]		26.19 [1.031]			30.18 [1.188]				
	e	47.63 [1.875]		52.37 [2.061]			58.72 [2.311]				
	f	3/8-16UNC-2B		3/8-16UNC-2B			7/16-14UNC-2B				

Dimensions

Model code examples and maximum shaft torque

Flange/drive gear configuration	Model code example	Maximum shaft torque N·m [lb·in]
07SA	SNP3NN/063LN07SAP1A5A4NNNN/NNNNN	270 [2389]
07GA	SNP3NN/026LN07GAP1A3A2NNNN/NNNNN	230 [2035]

For further details on ordering, see [Model code](#) on page 8.

Products we offer:

- DCV directional control valves
- Electric converters
- Electric machines
- Electric motors
- Gear motors
- Gear pumps
- Hydrostatic motors
- Hydrostatic pumps
- Orbital motors
- PLUS+1® controllers
- PLUS+1® displays
- PLUS+1® joysticks and pedals
- PLUS+1® operator interfaces
- PLUS+1® sensors
- PLUS+1® software
- PLUS+1® software services, support and training
- Position controls and sensors
- PVG proportional valves
- Steering components and systems
- Telematics

Danfoss Power Solutions is a global manufacturer and supplier of high-quality hydraulic and electric components. We specialize in providing state-of-the-art technology and solutions that excel in the harsh operating conditions of the mobile off-highway market as well as the marine sector. Building on our extensive applications expertise, we work closely with you to ensure exceptional performance for a broad range of applications. We help you and other customers around the world speed up system development, reduce costs and bring vehicles and vessels to market faster.

Danfoss Power Solutions – your strongest partner in mobile hydraulics and mobile electrification.

Go to www.danfoss.com for further product information.

We offer you expert worldwide support for ensuring the best possible solutions for outstanding performance. And with an extensive network of Global Service Partners, we also provide you with comprehensive global service for all of our components.

Hydro-Gear

www.hydro-gear.com

Daikin-Sauer-Danfoss

www.daikin-sauer-danfoss.com

Local address:

**Danfoss
Power Solutions (US) Company**
2800 East 13th Street
Ames, IA 50010, USA
Phone: +1 515 239 6000

**Danfoss
Power Solutions GmbH & Co. OHG**
Krokamp 35
D-24539 Neumünster, Germany
Phone: +49 4321 871 0

**Danfoss
Power Solutions ApS**
Nordborgvej 81
DK-6430 Nordborg, Denmark
Phone: +45 7488 2222

**Danfoss
Power Solutions Trading
(Shanghai) Co., Ltd.**
Building #22, No. 1000 Jin Hai Rd
Jin Qiao, Pudong New District
Shanghai, China 201206
Phone: +86 21 2080 6201

Danfoss can accept no responsibility for possible errors in catalogues, brochures and other printed material. Danfoss reserves the right to alter its products without notice. This also applies to products already on order provided that such alterations can be made without subsequent changes being necessary in specifications already agreed. All trademarks in this material are property of the respective companies. Danfoss and the Danfoss logotype are trademarks of Danfoss A/S. All rights reserved.